



X-TYPE

QUICK START GUIDE

VEHICLE ACCESS AND DOOR CONTROLS	02
COMFORT ADJUSTMENTS	04
FACIA	07
DRIVING	08
STEERING WHEEL CONTROLS	11
AUDIO SYSTEM	12
NAVIGATION AND TELEPHONE SYSTEMS	14
FILLING STATION INFORMATION	16

SOME OF THE INFORMATION IN THIS GUIDE MAY NOT APPLY TO YOUR VEHICLE.
YOU MUST REFER TO THE OWNER'S HANDBOOK FOR FULL OPERATING INSTRUCTIONS



JAGUAR

Vehicle access and door controls

Locking and unlocking

 Press once to lock the vehicle and arm the alarm.

Press twice within three seconds to double lock the vehicle.

Press and hold to close all windows and sunroof (**Global closing**).

 Press once to disarm the alarm, unlock the driver's door and the luggage compartment.

Press again to unlock remaining doors.

Press and hold to open all windows and sunroof (**Global opening**).

 Press once to switch the headlamps on for 25 seconds. Press again to switch off.

 Press to unlock and open the luggage compartment. **Note:** Operation of this button is inhibited when the key is in the starter switch

Unlocking with the door key

If the vehicle is unlocked with the door key, the key must be inserted into the starter switch within 15 seconds to prevent alarm activation.



Door Key release

Press the arrowed button to release the door key.

Unlocking mode alternatives

Single-point entry allows only the driver's door to unlock with a single press. A second press unlocks all other doors and luggage area.

Multi-point entry will unlock all doors and luggage area with a single press.

To change between modes, press the lock and unlock buttons simultaneously for four seconds. The hazard warning lamps will flash twice to confirm the change.

Central door locking

To lock all doors, press the interior lock lever on either front door.

To unlock all doors, pull the interior lock lever on either front door.

Drive away door locking

The doors and luggage compartment will automatically lock when forward speed exceeds 7 km/h (5 mph).

This feature can be disabled by your Jaguar Dealer/Authorised Repairer.

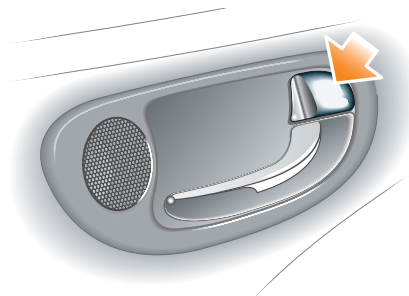

Luggage compartment

Opening the luggage compartment

With the vehicle locked and alarm armed:

- Press the luggage compartment button on the remote handset.

With the vehicle unlocked:

- Press the release button 1 on the luggage compartment lid/tailgate, located on the underside of the chrome finisher.

Opening the tailgate glass - Estate

Press the release button 2, located on the reverse of the tailgate handle and lift the glass.

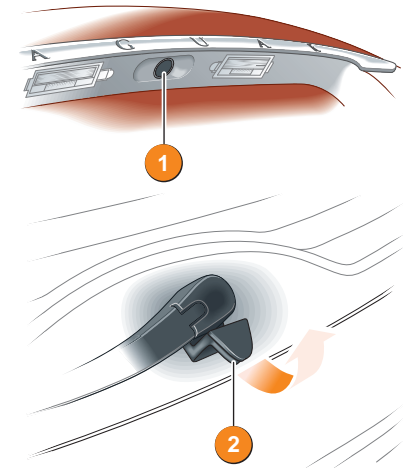

Care Point

The luggage compartment release button is disabled when the vehicle is locked with the remote control.

Windows and door mirrors

Resonance with lowered windows

If a resonance/booming sound occurs when a rear window is open, lowering an adjacent front window about 25 mm (1 inch) will eliminate the condition.

Windows

The windows can be fully opened or closed with a single operation of the switch.

- To open a window, briefly press the respective switch 1.
- To close a window, briefly pull the switch up.
- Operate the switch again to stop window movement.
- Press button 2 to inhibit operation of rear window switches.

Reminder - Global closing

If any apertures are left open when leaving the vehicle and global closing is enabled, press and hold the remote handset lock button to close them.

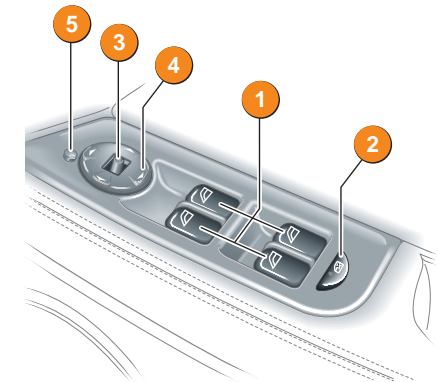

Door mirror adjustment

Press the left or right button 3 to select a mirror. Use the four-way switch 4 to adjust the position of the selected mirror.

Powerfold mirrors (when fitted)

Press button 5 to fold the mirrors inwards towards the doors. Press again to unfold.

Comfort adjustments

Seat adjustment

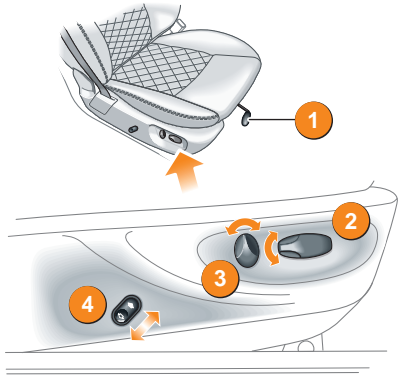

Dependent on vehicle specification, seats can be adjusted in up to 10 directions.

1. **Manual adjustment**, forwards and back - lift and slide seat to position.
Electric adjustment, forwards and back, cushion height and cushion tilt.
2. Seat height.
3. Seat back angle.
4. Lumbar support.

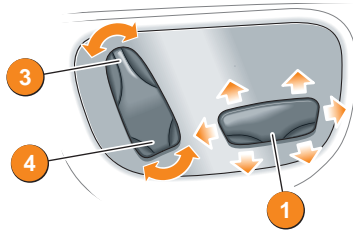

Driving position memory

Driver's seat

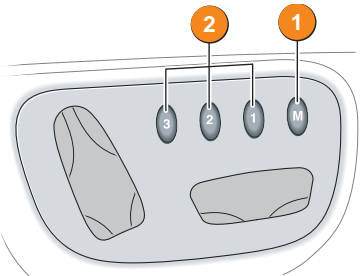

Once you have adjusted the driver's seat and exterior mirrors for your ideal driving position, the settings can be memorised for future use.

1. Press the **M** button located on the driver's seat switchpack. A chime will sound to indicate the seat is in memory mode.
2. Within 5 seconds, press button **1**, **2** or **3** to memorise the current settings.

A double chime confirms that memory is set. Any existing settings will be overwritten.

Recalling a seat position

Press button **1**, **2** or **3**. Automatic transmission must be in **P** (Park) or **N** (Neutral), or in vehicles with manual transmission, the starter switch must be off

Steering wheel adjustment

Push the steering column adjustment lever downwards.

Move the steering wheel to the required position, then fully raise the lever to lock the steering column in position.

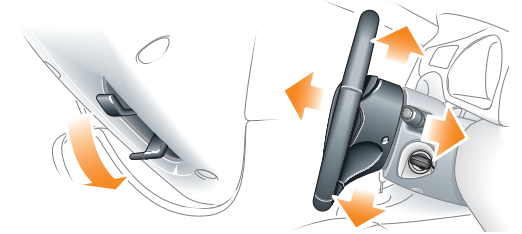

Seat belts and child restraints



A warning indicator on the instrument pack will illuminate if a front seat belt is unbuckled. This may be accompanied by an intermittent chime.

Child Seats

It is important to remember that a child's weight, rather than age, determines the type of seat that is required.

Refer to **Child Safety** in the Owner's Handbook to determine the correct seat for your child.

Rear centre seat belt interlock - Estate only

The centre rear seat belt is anchored to the back of the seat. If the seat backrest is not correctly latched, the seat belt reel will not extend.

Recommended child seat

For saloon car variants, Jaguar Cars recommends ISOFIX child restraints with a top tether.

An ISOFIX child seat can be fitted only in the outer rear seating positions.

Jaguar Cars recommends that a child seat is installed only in an outer rear seat.

Passenger airbag deactivation



The front passenger seat occupancy sensor determines the state of seat occupancy and sets the airbag status to suit:

- Seat unoccupied - airbag deactivated and indicator off.
- Seat occupied - airbag activated and indicator on.
- Low weight occupant or object - air bag deactivated and indicator on.

Climate control



1. CLIMATE.

Press to select climate control touch screen.

2. A/C (Air conditioning).

Press to provide cooled and dehumidified air for occupant comfort; the dry airflow is also effective in preventing misting of the windows.

Air conditioning is controlled automatically when the vehicle is in **AUTO** mode.

Deselecting **A/C** will cancel **AUTO** mode.

External water deposits

The air conditioning system removes moisture from the air and deposits excess water beneath the vehicle. Puddles may form, but this is normal and no cause for concern.

3. AUTO.

Press to select automatic operation of the climate control system.

The climate control will automatically adjust heat, blower speed, air intake and airflow distribution to maintain the selected temperature(s) and reduce window misting, without constant manual adjustments.

Front and rear screen heating and timed air recirculation may be selected in **AUTO** mode. Selecting any other function will cancel **AUTO** operation.

Recommended mode

Select **AUTO** as the normal operating mode. This will help prevent window misting.

4. Temperature selection.

Press the red or blue buttons to adjust temperature. To quickly jump from **HI** or **LO** to a mid-range temperature setting, press and hold the **AUTO** button for a few seconds.



5. R (Heated rear screen and door mirrors).

6. F (Heated front screen).

7. DEF (Defrost and demist mode).

Press to remove frost or heavy misting from the screens. The front and rear screen and door mirror heaters will be activated. Air conditioning will operate and the blower operates at high speed. Speed can be manually adjusted.

To deselect air conditioning and blower, press **DEF** again or **AUTO**.

8. Air recirculation.

Press to stop outside odours from entering the vehicle or to improve performance of the air conditioning system in regions of high ambient temperatures.

Press to switch the timed air recirculation system on or off.

9. Air distribution controls.

To face.

To face and feet.

To feet.

To front screen and feet.

Heated seats (not illustrated)

There are two temperature settings. Press the required seat button on the centre console to initiate.

- First touch - maximum heat.
- Second touch - intermediate.
- Third touch - heating off.

The setting will be indicated by a red or yellow indicator lamp in the button..

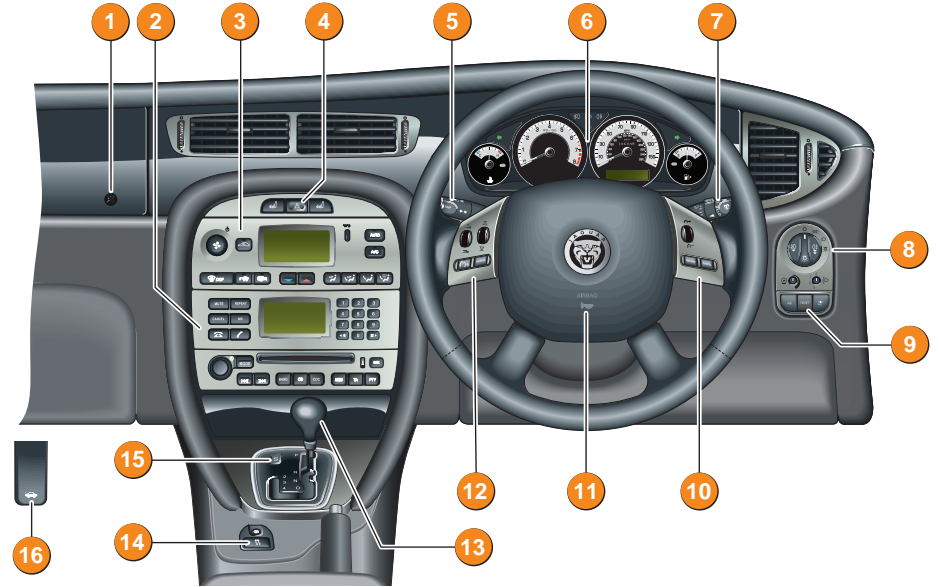

1. Passenger airbag deactivation indicator

2. Audio system

3. Heating and ventilation system

4. Hazard warning switch

5. Direction indicators and trip computer switch

6. Instrument pack and warning indicators

7. Wiper and washer switch

8. Lamps master switch

9. Trip computer reset switch

10. Cruise control switches

11. Horn

12. Audio switches

13. Gear selector lever

14. Dynamic Stability Control (DSC) switch

15. Sport mode button

16. Bonnet release

Warning lamps

The following will illuminate during normal driving to indicate that a related system or feature is operating. If any other warning lamp illuminates, refer to the Owner's Handbook.



Seat belt reminder



Parkbrake on



Door or luggage compartment open



Diesel glow plugs active



Side lamps on



Headlamp high beam on



Front fog lamps on



Rear fog lamps on



Direction indicator



Cruise control active

Exterior lighting

Exterior lamps master switch

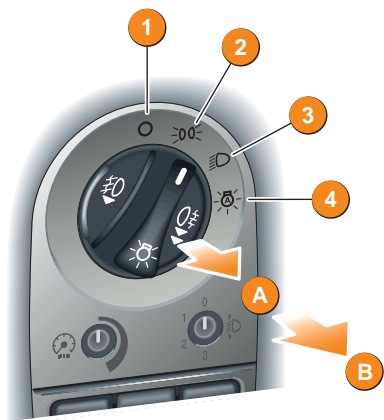

1. Exterior lamps off
2. Side lamps
3. Dipped headlamps
4. Autolamps

- A. Front fog lamps**
Pull the switch to position **A** to switch on the front fog lamps.
- B. Rear fog lamps**
Pull the switch to position **B** to switch on the front and rear fog lamps.

Autolamps operation

When Autolamps is selected, a sensor monitors the exterior light levels and automatically switches the side lamps and dipped headlamps on and off. If the windscreen wipers are operated continuously for more than 20 seconds, the exterior lamps will operate automatically.

Operating note

Fog lamps can only be operated when the master switch is in either position 2 or 3.

Sunroof and parking aid

Sunroof

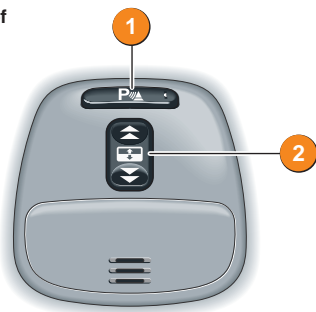

The sunroof can be fully opened or closed with a single operation of switch 2 in the overhead console.

Remote closing

If the sunroof has been left open when leaving the vehicle, it can be closed by pressing and holding the lock button on the remote handset.

Parking assist

Press button 1 to turn the front and rear parking sensors on or off. An indicator will illuminate in the switch when parking assist is active.

Parking assist is on standby when the ignition is switched on. When reverse or **R** is selected, the parking aids are activated.

If an object is detected, an audible alert is triggered that increases in frequency as the object is approached.

Parking assist is cancelled when neutral or **N** is selected or a drive gear or **D** is selected.

Parking assist care points

Sensors may activate when water, snow or ice are detected on the surface of the sensors. Regular cleaning will aid performance.

Parking assist may sound if it detects a signal operating at the same frequency to that of the sensors (e.g. motorcycles, airbrakes).

Wipers and washers

Windscreen wipers

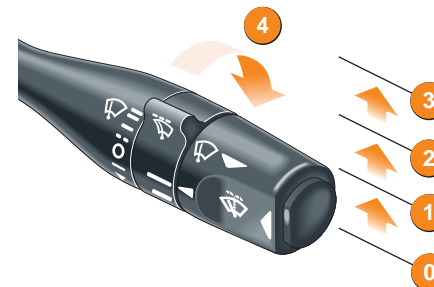

0. Off position.
1. Intermittent wipe.
2. Low speed operation.
3. High speed operation.
4. Rotary collar.

When intermittent wipe is selected, the interval between wipes can be varied by turning the rotary collar 4.

Windscreen washer

Press the button for windscreen wash and wipe.

Automatic operation

The wiper lever must be in position 1 and **AUTO** selected on the collar to enable automatic operation of the wipers.

Operation of single wipe

Saloon models - Pull the lever towards you for a single wipe. Holding the lever in this position will operate the wiper continuously until released.

Estate models - Push the lever downwards through the off position 0 for a single wipe. Holding the lever in this position will operate the wiper continuously until released.

Rear wiper and washer



Push the lever to position 1 for intermittent operation of the rear wiper. Push and hold the lever in position 2 to operate the rear washer and wiper.

Exterior lamps/Trip computer

- Move up or down to operate the direction indicators.
- For high beam flash, pull towards the steering wheel to first stop point.
- For high beam, pull fully towards the steering wheel and release. To switch off high beam, pull towards steering wheel and release.
- Press to view trip information in the message centre. Press repeatedly to cycle through TRIP, ODOMETER and MESSAGES. If Jaguar navigation is fitted, CLOCK will also be displayed.

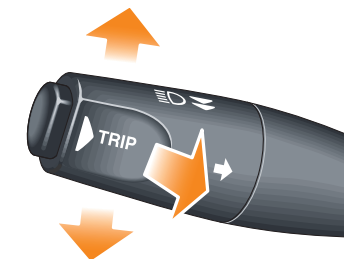

Automatic transmission

Gearshift interlock

Starter switch must be in position **II** and the foot brake applied before the gear selector can be moved from **P** (Park) to **R** (Reverse).

The lever can be moved into **P** with the starter switch off.

Petrol vehicles transmission

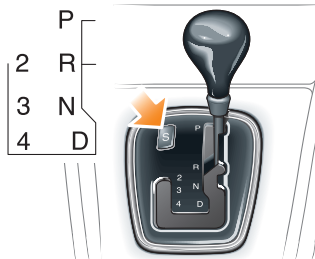

Diesel vehicles transmission

The selector release button must also be pressed to allow movement from **P** to **R**.



Diesel particulate filter (DPF)

The DPF captures a high proportion of sooty particles before they leave the exhaust. The particles are stored in the exhaust system until a regeneration procedure burns them away and the filter is emptied.

Regeneration procedure

If **DPF FULL** appears in the message centre, carry out the following procedure.

1. Drive the vehicle until the engine reaches normal operating temperature.
2. Drive for a further twenty minutes, keeping the road speed above 48 km/h (30 mph).

Gear selector

The selector lever is designed to accommodate two different gear selection techniques:

Automatic selection: P, R, N and D.

When moving from **N** or **P** to **R** or **D**, wait briefly for the transmission to engage before accelerating.

Manual selection - petrol: Use the left-hand side of the selector gate to individually select 4th, 3rd or 2nd gear.

Jaguar Sequential Shift - diesel: Move the selector lever across from **D** to **S** (Sport) then forward or back for manual gear selection. The selected gear is displayed in the message centre.

Sport mode

This is an automatic gear change mode, however, change points are modified to make full use of engine power.

Petrol - Press the switch (arrowed) to select. A red indicator in the switch will illuminate.

Diesel - Move the selector lever across from **D** to **S** (Sport). **SPORT** is displayed in the message centre.

When Sport mode is active, fuel consumption is adversely affected.

3. If regeneration is successful, the **DPF FULL** message will extinguish. If it does not extinguish, repeat the process.

Note: If the DPF FULL message fails to extinguish after three regeneration cycles, contact your Dealer/Authorised Repairer for assistance.

Diesel Particulate Filter (DPF)

If the message **DPF FULL SEE HANDBOOK** is displayed, refer to **Fuel and Refuelling** in the Owner's Handbook.

Cruise (speed) control

The cruise control system will maintain a set road speed until either cruise control is cancelled, or the brake or clutch pedal is used.

The system is controlled via switches on the steering wheel:

1. **SET** - Rotate the thumb wheel to the + position and release the accelerator pedal to set and maintain the vehicle's current speed. The message **CRUISE ENGAGED** briefly appears in the message centre. The speed can be increased or decreased by rotating the thumb wheel to the + or - positions.
2. **RESUME** - to resume a set speed retained in memory.
3. **CANCEL** - cancels cruise control but retains the set speed in memory.

When the vehicle is accelerated above the set speed, cruise control cancels, but resumes when the vehicle slows down to the set speed.

The message **CRUISE CANCELLED** or **CRUISE ENGAGED** appears in the message centre to indicate the status of the system.

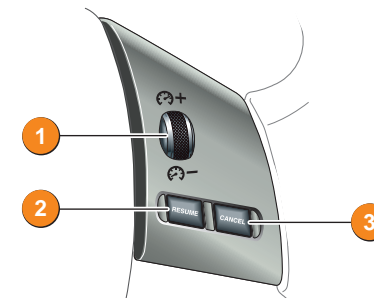

Operating note

Cruise control will automatically disengage when the vehicle speed falls below 28 km/h (18 mph).

Cruise control will only be engaged when the required speed has been set and the accelerator pedal released.

Audio controls

Steering wheel controls

1. Press to mute audio unit (non-voice only).
2. Rotate to adjust volume.
3. Press and release to cycle through Radio, FM, AM, DAB1, DAB2, CD and CD multichanger.
4. Rotate and release to cycle through preset radio stations or the next CD track. Rotate and hold for at least two seconds to cycle to the next strongest station or to next CD.

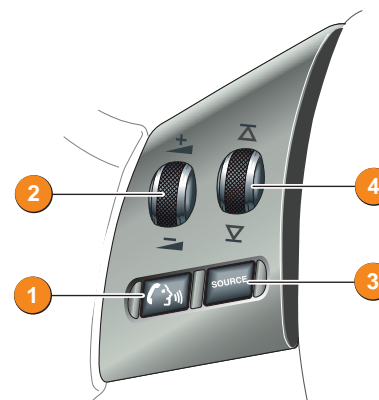

Radio operation

General operation

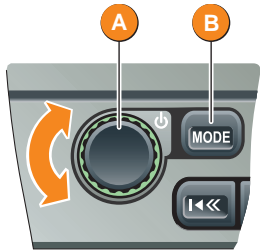

Press the rotary control **A** to switch the audio system on or off and rotate to adjust the volume.

To adjust the sound settings, press the **MODE** button **B** repeatedly, until the required setting is displayed. Turn the control knob **A** to adjust the level or rating.

After approximately five seconds, the system will return to normal control mode.

Radio controls

BAND To move from another mode to radio, press the **BAND** button. Press repeatedly to scroll through DAB1, DAB2, FM, MW and LW wavebands.

Seek Press an arrow button to search (Seek) for a radio station.

Radio presets

Once a radio station has been tuned, press and hold the desired preset button (or touch a station position on the touch-screen) until a beep is heard. The preset is now stored.

A total of nine presets can be stored for each waveband.

A MEM The radio presets can be automatically set by using the Auto Memory function. Press and hold the **A MEM** button for two seconds. The radio will be briefly muted while it searches the selected waveband for the nine strongest stations.

Traffic Announcements

TA To activate this function, press and release the **TA** button. With TA activated, traffic announcements will interrupt radio or CD play. To deactivate this feature, press and release the **TA** button again.

Press and hold the **TA** button for two seconds to display the radio station name instead of the frequency.

Radio with Touch-screen

To move from another operating mode to radio mode, press the **AUDIO** button.

To adjust audio volume presets, press the **MENU VOLUME**. Use the + and - controls to adjust volumes.

Press the **BAND** button repeatedly to cycle through wavebands.

Use the touch-screen buttons to select a radio station.

Press and hold the **A MEM** button for two seconds. The radio will be briefly muted while it searches the selected waveband for the nine strongest stations.

Digital Audio Broadcast (DAB) radio

DAB radio delivers a clear signal with no interference, hiss or fading. There are many more DAB channels than those available via analogue broadcasting.

BAND To receive digital broadcasts, press the **BAND** button repeatedly to choose either **DAB1** or **DAB2**.

The first time a DAB source is selected, dependant on the type of audio system fitted, **NO CHANNEL** or **NO CHANNEL FOUND** is displayed.

Press the **A MEM** button or touch screen **TUNE** button to build a list of all the digital ensembles and channels which are available in your region.

Up to 9 of these channels can be stored on the **DAB1** and **DAB2** channel preset buttons.

When tuning is complete the first channel found will start playing. To move to the next channel, press the Seek arrow buttons.

To store a playing channel, touch a preset button for 2 seconds until a beep is heard. Repeat procedure with the other preset buttons. Stored channel names will be shown on the display screen or the touch buttons. Use the preset buttons to recall stored channels.

Reception loss

When reception is lost, **NO RECEPTION** will be displayed. This will be either a temporary loss or you have reached the limit of the broadcast area.

CD operation

Single CD player

CD If the radio or CD multichanger is being used, pressing the **CD** button will resume playing any CD installed in the player mechanism.

When a CD is loaded into the aperture, it will begin to load and play automatically.

Pressing the **CD** button, whilst in CD play mode, will pause the current track. A subsequent press of the **CD** button will resume play mode.

Seek To skip tracks, repeatedly press a Seek arrow button to move back or forward accordingly. Press and hold a button to cue and review CD tracks.

Eject When a disc is inserted, the CD icon is displayed. Press the disc **Eject** button to eject the CD. The display will show **DISC EJECT** and the CD icon will be turned off.

CD multichanger

Six discs can be loaded into the multichanger unit, and a further single disc in the audio console (when fitted).

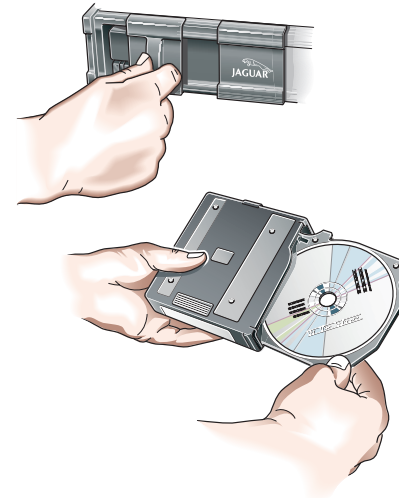

Care point

Remember to close the multichanger door - this will prevent dirt getting into the unit and help reduce skipping.

Loading CD's

The CD multichanger is located in the luggage compartment. To load a CD into the multichanger:

- Slide open the multichanger door, press the **Eject** button and remove the magazine. Close the door.
- Pull a tray out from the magazine and insert a CD (label side up). Slide tray into magazine until a click is heard.
- Slide open the multichanger door and ensuring correct orientation, replace the magazine. Make sure the magazine clicks into position.

CD selection

CDC 1. Press the **CDC** button to select the CD multichanger mode.

2. Press preset buttons **1** to **6** to select the appropriate CD loaded in the multichanger.

If a touch-screen is fitted to the vehicle, disc selection can be made by touching the relevant numbered disc icon.

3. When playing a CD, press the **CDC** button to pause play. Press again to continue play.

Playing random tracks

MIX To play random tracks from the disc, press and release the **MIX** button. To cancel, press the **MIX** button again.

To play random tracks from all discs loaded in the multichanger, press the **MIX** button for two seconds. To cancel, press and hold the **MIX** button.

Navigation and telephone systems

Touch-screen navigation

The screen requires only a light touch to operate the function. Excess pressure could result in damage. On initial activation, make sure that both the correct country and area have been selected.

Route Preferences should be checked and selected prior to setting a destination. Access via **Nav menu** then **Route Options**.

Setting a destination

To set a destination and start using the navigation system, use the following procedure:

1. With the vehicle stationary, press the **NAV** button. When prompted, touch **Agree** on the touch-screen to access the initial map screen.



2. Touch **Nav Menu** to access the navigation menu, and then touch **Destination Entry**.
3. Touch either **Address** or **Postcode**.
4. Enter the address or postcode using the on-screen keypad, ensuring a space (arrowed key) is entered in the postcode. Touch **OK** to enter.



5. Touch **Dest** to calculate the route.
6. Once calculated, the screen displays the route. To scroll through alternative routes, touch **Next** on the screen.

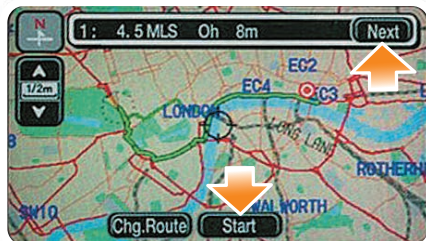

7. Touch **Start** to commence navigation. Drive away, following the voice guidance.

When your destination is reached, voice and visual confirmation is given.

 During navigation guidance, touch the **Audible repeat** icon to hear the last voice instruction again. Audible guidance can be selected or deselected via the **Nav menu**.

Cancelling guidance

Touch **Nav Menu**, select **Route options**, **Cancel guidance** and touch **Confirm**.

Bluetooth telephones

Compatible Bluetooth mobiles can communicate with the inbuilt telephone system. Connection must be made with ignition on or engine running.

Bluetooth phone compatibility

For the latest list of phones and their softwares fully compatible with the Jaguar system, refer to www.ownerinfo.jaguar.com or consult your Jaguar Dealer.

Use the following procedure in conjunction with your phone manufacturer's instructions.

Initial pairing of your phone to the vehicle

1. Turn the starter switch to position **II**.
2. Press the  button on the audio panel. Ensure that no mobile phone is connected to the system. The touch-screen will display the message **Discover me**. On non-touch-screen systems the message **SIG****** or **SIG******* will be displayed.
3. Prepare the handset for pairing to the system.

See the telephone manufacturer's instructions for further details, or follow the table below for generic commands.

When successfully paired, the touch-screen message changes to **REGISTERED** followed by **PHONE CONNECTED**.

	Nokia	Motorola	Ericsson
1	Select Menu	Select Menu	Select Menu
2	Select Settings	Select Settings	Select Connectivity
3	Select Bluetooth or Connectivity then Bluetooth	Select Connection	Select Bluetooth
4	Select On	Select Bluetooth link	Select My Devices
5	Select Search for Audio devices	Select Hands-free	With New Device highlighted, select Add. Press OK to confirm
6	After search, select Jaguar	Select Look for devices	After search, select Jaguar
7	Enter pass code 1313. Press OK to confirm	After search, select Jaguar	Select Connect
8	No connection? Select Bluetooth (Menu) then Paired devices Jaguar	Permission to Bond? Select Yes and enter pass code 1313	Enter pass code 1313 after prompt

On non-touch-screen systems, the audio system message changes to **SIG ***.





For best results when pairing your handset to the system, ensure the handset is fully charged.

Downloading phone book entries



1. Turn the starter switch to position **II**, and make sure the handset is paired to the vehicle's system.
2. Press the  button.
3. Switch off the starter switch and wait for your phone to disconnect from the vehicle to allow the system to complete the download process.

Making a call



1. Press and hold the **SOURCE** switch on the steering wheel control, or press  on the audio panel. **Phone** will be displayed.
2. Key in the phone number required using the on-screen or audio panel keyboard.
3. Press  on the steering wheel control, or  on the audio panel. **Calling** will be displayed.
4. To end call, press  on the steering wheel control, or  on the audio panel.

Receiving or ending a call

To answer or end a call, press  or .

Filling station information

Fuel filling

Fuel filler flap location

 A small arrow on the fuel gauge indicates which side the fuel filler is located.

Fuel filler flap release

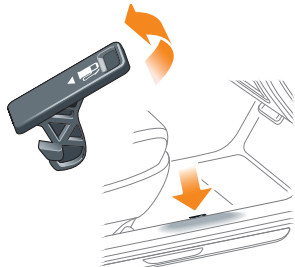

The fuel filler flap release is located on the floor, outboard of the driver's seat.

Pull the lever to release the fuel filler flap.

Docking the filler cap

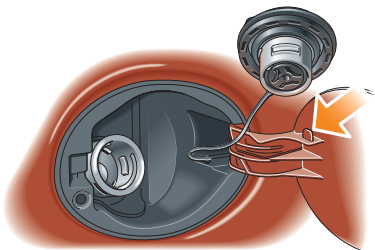

The filler cap is secured to the vehicle by a strap. A hook is provided on the flap to hold the cap whilst refuelling.

Equipment necessary for use of fuels containing more than 10 per cent ethanol is not fitted to this vehicle.

Do not use E85 fuels (85 per cent ethanol content). If E85 fuels are used serious engine and fuel system damage will occur.

Tyre pressure label

Tyre pressure label location

Tyre pressures are shown on a label attached to the end of the fascia on the driver's side of the vehicle.

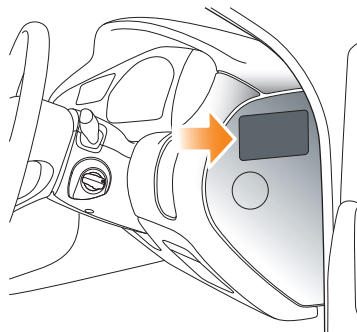

TYRE PRESSURE REMINDER

For ease of reference you can record the tyre pressures specific to your vehicle in the spaces below.

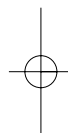

	Front	Rear
Normal Driving		
Laden/ High Speed		

Incorrect fuelling

If the vehicle is filled with the wrong type of fuel:

- DO NOT start the engine!
- Call for Roadside Assistance!