2002MY Navigation Handbook



BY APPOINTMENT TO
HER MAJESTY QUEEN ELIZABETH II
MANUFACTURERS OF DAIMLER AND JAGUAR CARS
JAGUAR CARS LIMITED COVENTRY



BY APPOINTMENT TO
HER MAJESTY QUEEN ELIZABETH
THE QUEEN MOTHER
MANUFACTURERS OF DAIMLER AND JAGUAR CARS
JAGUAR CARS LIMITED COVENTRY



BY APPOINTMENT TO
HIS ROYAL HIGHNESS THE PRINCE OF WALES
MANUFACTURERS OF DAIMLER AND JAGUAR CARS
JAGUAR CARS LIMITED COVENTRY

Navigation Handbook

JAGUAR CARS LIMITED, as manufacturer, is dedicated to the design and production of vehicles which meet the expectations of the world's most discerning purchasers.

This handbook forms part of the owner literature supplied with your vehicle. It is designed to complement the relevant features and systems of the vehicle, and make them easy to understand and operate.

The information contained in this handbook applies to a range of vehicles and not to a specific vehicle. For the specification of a particular vehicle, owners should consult their Jaguar Dealer.

The manufacturer reserves the right to vary its specifications with or without notice, and at such times and in such manner as it thinks fit. Major as well as minor changes may be involved in accordance with the Manufacturer's policy of constant product improvement.

To cover changes, it is sometimes necessary to issue one or more handbook supplements. When reading this handbook, check the owner literature for possible supplements.

For full details of the owner literature originally supplied with the vehicle, owners should consult their Jaguar Dealer.

All rights reserved. No part of this publication may be reproduced, stored in a retrieval system or transmitted, in any form, electronic, mechanical, photocopying, recording or other means without prior written permission from the Service Division of Jaguar Cars Limited.

Contents

1. Introduction to the system

Introduction	1-1
Using the system.	1-2
Safety information	1-3
Control panel	1-6
Loading the map DVD	1-6
Getting started	1-7

2. Introduction to basic screen displays

Screen displays	2-1
Function of on-screen control icons	2-4
Function of on-screen control buttons	2-6
Text input	2-8

3. Route setting simple example

Route setting example.	3-1
--------------------------------	-----

4. Quick reference

Main features of the system	4-1
Frequently used functions.	4-2
Menu structure	4-3
POI category list	4-4

5. Menu structure

Initial map display.	5-1
Navigation menu.	5-3
Route options menu	5-4
Navigation set up menu	5-7
Display options	5-10
Quick points of interest (POI)	5-11
Memory points	5-13
Perspective views	5-14
Using perspective view	5-15

6. Route setting

Destination entry menu.	6-1
By address.	6-3
Using a memory point	6-6
Using the home position	6-7
Using a point of interest (POI)	6-8
Using a previous destination	6-13
Using a postcode.	6-14
Using a map location.	6-15
Using a motorway entrance/exit	6-16
Using an intersection.	6-17

7. Using stored locations

Working with stored locations	7-1
Memory points.	7-2
Home.	7-4
Avoid area	7-5
Previous destination.	7-6
Destination and way point	7-7

8. Route calculation and guidance

Route calculation	8-1
Storing way points	8-3
Route guidance	8-5
Screen types.	8-9

A comprehensive index is located at the back of this Handbook.

Introduction

This Jaguar navigation system assists the driver by providing a route to a selected destination. Guidance is given by means of audible instructions (voice guidance), complemented by map and turn information, which is displayed on an LCD screen. Digital map information is held on a digital versatile disc (DVD), which is loaded into the navigation control unit housed in the luggage compartment.

The system has an extremely comprehensive range of features, yet is easy to use. Some time spent reading this handbook will ensure that the best results are obtained.

The LCD screen provides full information for operating the system by means of menus, text screens and map displays. Screen selections are made by the touch controls shown on the screen.

How the system works

The system uses signals from the Global Positioning System (GPS) satellites, which allow the approximate position of the vehicle to be calculated. This is combined with information from vehicle sensors and data from the map DVD to establish the true vehicle position.



WARNING:

- 1. The Database reflects reality as existing before you received the Database and it comprises data and information from government and other sources, which may contain errors and omissions. Accordingly, the Database may contain inaccurate or incomplete information due to the passage of time, changing circumstances, and due to the nature of the sources used. The Database does not include or reflect information on – inter alia – neighbourhood safety; law enforcement; emergency assistance; construction work; road or lane closures; vehicle or speed restrictions; road slope or grade;**

bridge height, weight or other limits; road or traffic conditions; special events; traffic congestion; or travel time.

- 2. Only operate, adjust or view the system when it is safe to do so.**

Clock adjustment

The clock may be a separate one or one which is displayed on the touch-screen. Refer to Section 1 of the Driver's Handbook.

Declaration of conformity



This navigation system conforms to the above standard, Directive 99/5/EC.

1-2 Introduction to the system

Using the system

Caution: If the system is used for an extended period of time with the vehicle stationary, ensure that the engine is running, to avoid draining the battery.

For best results, always use the latest version of the map DVD (navigable map database). Map information is regularly updated, but all areas are not necessarily covered to the same level of detail. Some areas, in particular private roads, may not be included on the database (non-digitised roads).

While driving under route guidance, follow an instruction only when it is safe to do so, as the system cannot be aware of changing conditions, for example turn restrictions, roadworks or diversions. Use voice guidance as much as possible, and only view the display when driving conditions permit.

About this handbook

This handbook shows the on-screen menus, explains how to operate the controls and gives an example showing how to set a destination.

The first four sections of this handbook describe the basic operations involved with using the system. The final four sections describe the system and its features in depth.

After becoming familiar with the controls, follow the on-screen menus and prompts, to operate the system as required.

To find a particular menu, see **Menu structure** on page 4-3. This information is repeated in the Operating Highlights booklet supplied with the literature pack.

Throughout the handbook, the expression 'Select an item' (or similar wording), means 'Touch the on-screen button adjacent to the item required'.

- Actions are indicated by this bullet symbol.

In-car telephone features

In this handbook, some features shown are only available when the vehicle is fitted with the Jaguar in-car phone installation. These features include the display of the telephone button, the end call button and one-touch dialling of POI numbers or memory points.

Using the system (continued)

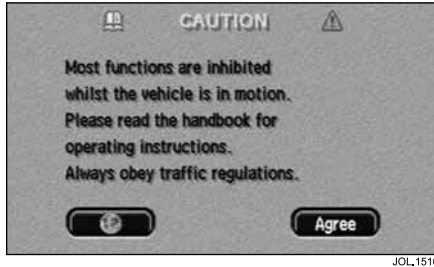

Safety information

IMPORTANT: Do not use the system until you have familiarised yourself with its operation.

The road safety caution is displayed each time the ignition is switched on, and the navigation system is selected.

The caution screen gives the following information:

Most functions are inhibited whilst the vehicle is in motion.

Please read the handbook for operating instructions.

Always obey traffic regulations.

- To use the system, read the caution and touch **Agree**.

Time and distance to destination

When a route is calculated, the estimated time required to drive the route and the total distance to the destination are determined. The time is based on the vehicle travelling at the current speed settings for each type of road (residential, main and motorway). The distance is based on the current route preference settings, e.g. Use Toll Roads Yes/No, see **Route preferences** on page 5-4.

While driving under guidance, the estimated time (if selected) and distance remaining to the end of the route are shown on the screen.

1-4 Introduction to the system

Using the system (continued)

Reception of GPS signals

GPS signals are highly directional and reception may occasionally be interrupted. Some examples of situations likely to cause problems are shown below:

- Inside tunnels.
- Inside buildings.
- Roads under raised highways.
- Densely tree-lined roads.
- Forest roads between mountains.
- Between tall buildings.
- Roads under cliffs.
- Metal objects placed on the rear parcel shelf.
- Having the vehicle windows tinted using metal oxide tinting. Non-metal tinting should be used.

Errors in vehicle position

Under certain driving conditions, it is possible that the vehicle position shown may be incorrect. Some examples are shown below:

- When the vehicle is transported by ferry or train.
- Driving on steep roads.
- After vehicle battery removal or supply fuse failure.
- When using snow chains.
- After the tyres have been replaced.
- After the vehicle has been rotated on a turntable.
- Where there are two roads parallel to each other.
- Elevated roads in proximity to other roads.
- Driving up or down circular ramps in car parks.

The position will usually be corrected automatically. If the problem persists, see **Calibration** on page 5-9, or consult your Jaguar Dealer.

Route guidance precision

Under certain driving conditions, it is possible that the route guidance may be inaccurate. Some examples are shown below:

- Deviation from a route may cause incorrect guidance until the route has been recalculated.
- Route guidance may occasionally be given where no turn is required.
- If there is no road or only a narrow track to the final destination, guidance will be given to the nearest point possible.
- No guidance is given while reversing.
- If driving at high speed or on very dense road networks, it may not be possible to recalculate the route in time for the next instruction.
- On familiar roads, personal route preferences may not always be followed.

Using the system (continued)

Jaguar Dealership locations

Details of Jaguar Dealerships are held on the map DVD as a points of interest (POI) category. Certain dealers may be located in areas that are not fully mapped on the DVD. If a route is set to one of these dealers, guidance will only be possible to the nearest town centre; a warning message will be displayed.

Alternative routes

During route calculation, up to three possible routes are calculated. The first route is calculated using the current route preference settings. The second route is also calculated using the preference settings, except that for Minimise Time/Distance, the alternative setting is used. For example, if Minimise Time is currently selected, then the second route will be calculated based on Minimise Distance, with the other settings as selected. For the third route, the system tries to find another alternative using different combinations of the preference settings. If a suitable alternative is not possible, only the first and second routes will be shown.

Languages and distance units

The screen text and voice guidance are available in a number of different languages. For the list of available languages, see **Language button** on page 1-7.

Distances are shown on the screen and given in voice guidance, either in Imperial units (miles) or in Metric units (kilometres and metres). For information on changing the selection, see the Driver's Handbook, section 1.

Town name lists

After entering a street name, the matching town entries found in the database are shown. Each entry includes some or all of the following: district name, town name, and county name.

Road junction layouts

The layout of complex road junctions may sometimes be shown in a simplified form. Some small roundabouts may not be shown.

Map DVDs

All the European countries covered by the system are included on the disc supplied. For the list of countries, see **Changing search area** on page 6-2.

Screen cleaning

For approved screen cleaners, see your Jaguar Dealer.

1-6 Introduction to the system

Using the system (continued)

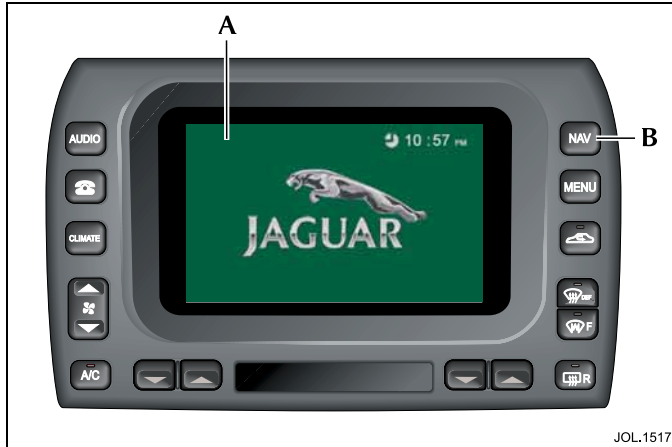

Control panel

A. LCD screen.

B. NAV button.

Navigation forms part of the overall vehicle telematics system, having a combined front panel and LCD screen (A). Navigation is selected by pushing the **NAV** button (B). The ignition must be switched on (position 'I').

Note: The navigation system is operated by using the touch buttons and icons displayed on the screen. For an explanation of the basic navigation touch controls, see **Function of on-screen control icons** on page 2-4.

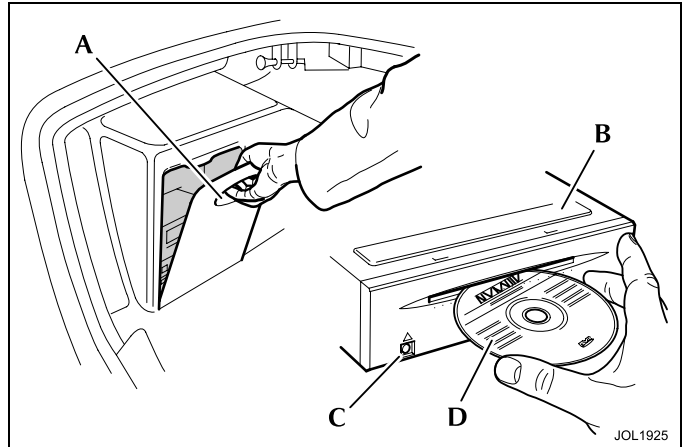

Loading the map DVD

Note: The ignition must be switched on (position 'I').

1. Pull the top of the access cover forward (A) and fold it down to the fully open position.
2. Identify the navigation unit (B), which is positioned above the sound system CD player (where fitted).
3. If a DVD is already loaded, push the eject button (C).
4. Load the DVD with the printed side upwards (D). Do not allow moisture or foreign objects to enter the slot.
5. Fold the access cover to the fully closed position. Check that the magnetic catch is properly secured.

Getting started

The following pages describe the Initial Map display of the system. From this screen, the Nav Menu can be accessed and then subsequently all other menus.



NAV button

The Navigation button is located on the bezel of the touch-screen panel.

- Press the **NAV** button to select the navigation system.

The road safety caution will be displayed.

Note: While the navigation system is selected, the **NAV** button has the following additional functions:

- Selects the initial map display from any other screen.
- After scrolling, returns the map display to show the current vehicle position again.



Road safety caution

The road safety caution is displayed the first time that the navigation system is selected after turning on the ignition.

- Touch **Agree** to acknowledge the road safety information.

The screen now shows the initial map display.



Language button

The screen text and voice guidance are available in a number of languages.

- To select a different language, touch the language button.
- Select the language required from the list displayed.

The languages available are:

- **Deutsch**
- **English**
- **English (US)**
- **Español**
- **Français**
- **Italiano**
- **Nederlands**
- **Dansk**
- **Svenska**

Note: This procedure changes the on-screen language for all the touch-screen systems. For more information, see the Driver's Handbook, section 1.

1-8 Introduction to the system

Getting started (continued)

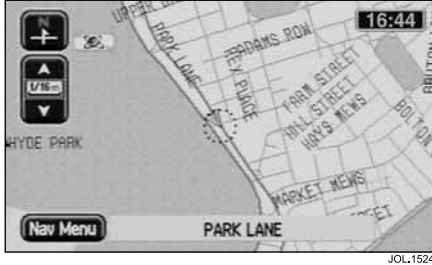

Initial map display

After touching **Agree**, the initial map screen showing the vehicle location is displayed, with the current road name shown in the text area at the bottom of the screen.

Touch controls

The touch controls displayed on the initial map screen are as follows:



Nav Menu button

Displays the Navigation menu, see **Navigation menu** on page 5-3.



Map orientation buttons

These buttons select the desired map orientation (north or vehicle heading to the top of the screen). The current selection is shown on the map.

Note: Above the 2 miles (4 kilometres) zoom level, only north orientation is available.



Zoom control

Selects the desired map zoom level by touching one of the arrow symbols. The currently selected scale is shown. See **Zoom control operation** on page 1-9.

Getting started (continued)

Additional touch buttons

These buttons are displayed after touching the map display.

Ent. Dest.

Ent. Dest. button

Stores a selected map location as a destination. See **Confirm destination** on page 8-1. (Displayed after touching the screen twice within five seconds.)

Store

Store button

Stores a selected map location as a memory point.

POI

POI button

Selects the quick points of interest function to display POI icons on the map. For more information, see **Quick points of interest (POI)** on page 5-11.



Zoom control operation

When the zoom control is touched, the scale indicator is shown on the screen. The scale markings shown on the indicator are: $\frac{1}{32}$, $\frac{1}{2}$, 4, 128 miles (50 m, 1 km, 8 km, 256 km).

The zoom control can be used in a number of ways as follows:

- Touch and hold one of the arrow buttons. The map is displayed at each zoom level in turn.
- Touch one of the arrow buttons repeatedly. The map is only displayed at the final zoom level.
- Touch one of the segments of the scale indicator. The map is displayed at the zoom level selected.

Search area/country change

The following applies to Europe only.

To reduce the time taken to calculate a route, the European map database is divided into countries, called Search Areas. When setting a route, the destination (or way point) being entered must be in the currently selected search area.

The first time that the navigation system is used, the driver should confirm that the correct country has been selected. Once set, it will remain correct for all future use; unless the battery is disconnected.

The search area is changed at the Destination Entry screen. Access to this screen is described with illustrations in steps 1 to 4, see **Route setting example** on page 3-1.

The procedure is briefly as follows:

- Switch ON the Ignition and press the **NAV** button located on the bezel of the touch-screen panel.

1 - 10 Introduction to the system

Getting started (continued)

- Press **Agree** on the Caution screen, press the **Nav Menu** button on the Initial Map screen, press **Destination Entry** on the Nav Menu screen.

The currently selected area is shown highlighted on the map.

To change the search area, press **Change**.

The countries which are available for selection are listed on the screen. They are also listed in this handbook, see **Changing search area** on page 6-2.

- From the list displayed, select the button required for the desired country.

The new selected country will now be shown highlighted.

Search area change Australia

To reduce the time taken to calculate a route, the map database is divided into Search Areas. When setting a route, the destination (or way point) being entered must be in the currently selected search area.

The first time that the navigation system is used, the driver should confirm that the correct area has been selected.

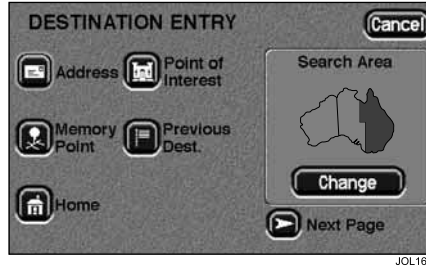

Once set, it will remain correct for all future use; unless the battery is disconnected.

The search area is changed at the Destination Entry screen.

The procedure is briefly as follows:

Switch ON the Ignition and press the **NAV** button located on the bezel of the touch-screen panel.

- Press **Agree** on the Caution screen, press the **Nav Menu** button on the Initial Map screen, press **Destination Entry** on the Nav Menu screen.

The currently selected area is shown highlighted on the map.

To change the search area, press **Change**.

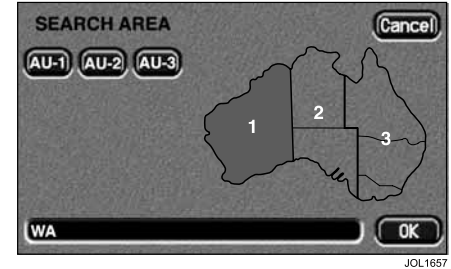

The areas which are available for selection are shown on the screen.

- Select the **AU-1**, **AU-2** or **AU-3** button as required for the desired area.

The new selected area will now be shown highlighted.

Getting started (continued)

End user licence agreement for Ordnance Survey (OS) data

Please read this agreement carefully before using the Navigation System.

This is a licence agreement to use the OS Code-Point data incorporated in the Navigation System. By using this Code-Point data you accept and agree to all the terms and conditions below.

Ownership

The OS Code-Point data is licensed by Ordnance Survey with permission of Her Majesty's Stationery Office. © Crown Copyright 2002. All rights reserved.

Licence grant

OS grants you a non-exclusive licence to use your copy of the OS Code-Point data for your personal use solely as part of the Navigation System. You may transfer the licence to a subsequent purchaser of the vehicle with which the Navigation System is supplied, provided that the purchaser agrees to abide by each of the terms of this licence.

Limitations of use

The OS Code-Point data is restricted for use in the specific system for which it was created. Except to the extent explicitly permitted by mandatory applicable laws, you may not extract or re-utilise any part of the contents of the OS Code-Point data, not reproduce, copy, modify, adapt, translate, disassemble, decompile, or reverse engineer any portion of the OS Code-Point data.

Limitation of liability

Ordnance Survey does not warrant or represent that any of the Code-Point data is accurate, error-free or suitable for your purposes. In no event shall OS or the supplier of the Navigation System using the OS Code-Point data be liable for any consequential, special, incidental or indirect damages for any direct or indirect loss of revenue, profits, business, data, or use, incurred by you or any third party arising out of your use of the OS Code-Point data, whether in an action in contract or tort (including negligence and breach of statutory duty) or otherwise, even if OS or the supplier of the Navigation System has been advised of the possibility of such damages. In any

event, OS's liability for direct damages is limited to the price of the copy of the OS Code-Point data. Nothing in these licence terms shall operate to exclude or limit any liability which cannot be excluded or limited by law.

THE DISCLAIMER OF WARRANTY AND LIMITATION OF LIABILITY, SET FORTH IN THIS AGREEMENT, DO NOT AFFECT OR PREJUDICE YOUR STATUTORY RIGHTS WHERE YOU HAVE ACQUIRED THE DATABASE OTHERWISE THAN IN THE COURSE OF A BUSINESS.

These licence terms are governed by English Law and are subject to the exclusive jurisdiction of the English courts.

Screen displays

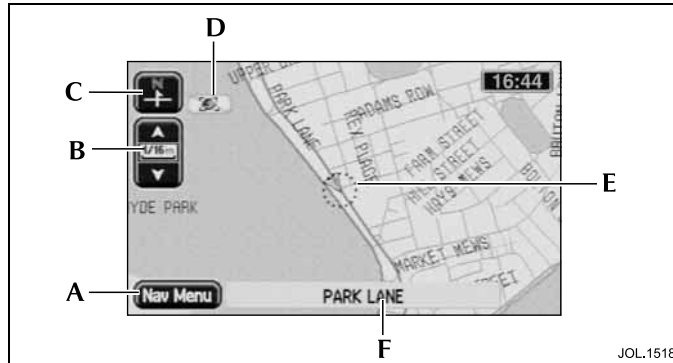

Initial map display

The initial map screen shows the current vehicle position. A key to the main features is given below:

- A. **Nav Menu button** – Touch button to select the Navigation menu.
- B. **Zoom control** – Touch control and indication of the current map zoom level. The scale length represents a distance of from $\frac{1}{32}$ mile to 128 miles (50 metres to 256 kilometres).
- C. **Map orientation** – Touch button and indication of the current map orientation (north or vehicle heading to the top of the screen). Above the 2 miles (4 kilometres) zoom level, only north orientation is available.

- D. **GPS icon** – Indicates that insufficient GPS satellite signals are being received for accurate map positioning. The icon is not displayed under normal operation.
 - E. **Map position icons** – The map normally indicates the current vehicle position (navigation icon). While the system is in use various icons are displayed, see **Function of on-screen control icons** on page 2-4.
 - F. **Lower text area** – Shows the current street name (present vehicle location). While operating the system, this text area is replaced by additional touch buttons.
- Note:** For an explanation of the basic navigation touch controls, see **Function of on-screen control buttons** on page 2-6.

Icons shown in top text area

The following small icons will be displayed in the top text area (see the area item 'C' on the next page) when their function has been set by the user.



Shown when a route has been set which includes toll payment areas.

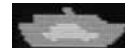

Shown when a route has been set which includes a ferry.

2-2 Introduction to basic screen displays

Screen displays (continued)

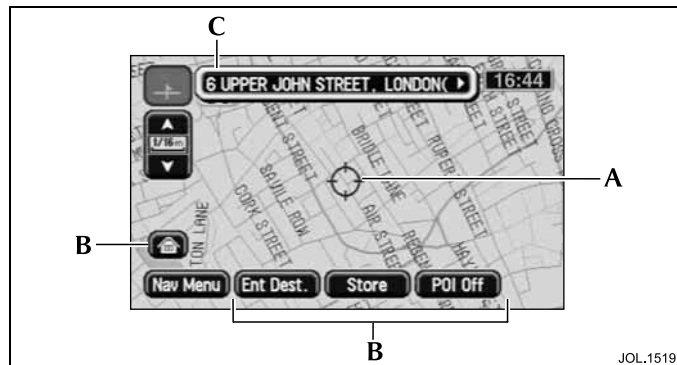

Scrolling the map

To scroll the map, use the touch-screen as follows:

- Touch the screen twice within five seconds. The cross-wire icon (A) is displayed, and the map scrolls until the point being touched is under the cross-wire icon.

Continuous scrolling

- Touch and hold at any point on the screen. The map continues to scroll while the screen is being touched.

Additional touch buttons

After touching the screen once, additional touch buttons (B) are displayed:

Home – Sets a route to the home position. (Only displayed when a home position has been set.)

Chg. Route – (see **Ent. Dest.** below) Displays the Route Options menu to make changes to the route preference settings. (Only displayed when a route has been set.)

Store – Stores a selected map location as a memory point.

POI – Selects the quick points of interest function to display POI icons on the map.

After touching the screen a second time within five seconds:

Ent. Dest. – Stores a selected map location as a destination. (Displayed in place of the **Chg. Route** button.)

Map location details

After scrolling, the address details of the map location under the cross-wire icon are shown in the text area at the top of the screen (C).

- If the complete address is not visible, touch anywhere within the text area to scroll the text to the left or right.

Selecting the initial map display

- Push **NAV** to return to the initial map display showing the current vehicle position.

Note: For an explanation of the basic navigation touch controls, see **Function of on-screen control buttons** on page 2-6.

Screen displays (continued)

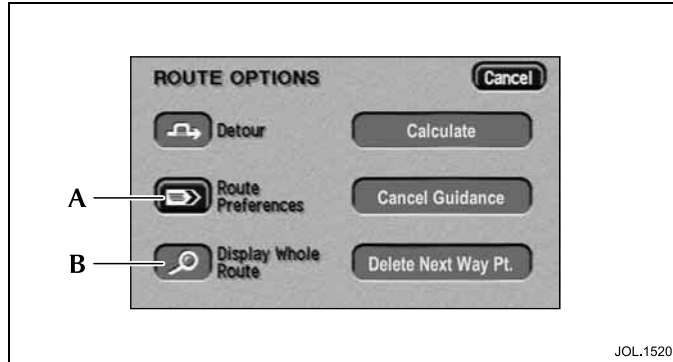

Menus

Menu screens are provided to select the various system functions. The Route Options menu is shown above as an example.

- To select a menu item, use the touch button (A) for the option required.

After selecting a menu item, the next sub-menu or screen will be displayed. If a menu item cannot currently be selected, it is highlighted in a lighter colour as shown (B).

Note: To find a particular menu, see **Menu structure** on page 4-3. This information is repeated in the Operating Highlights booklet supplied with the literature pack.

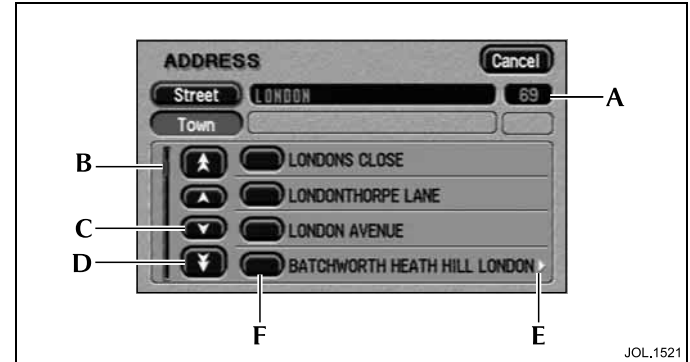

Name lists

Lists of names (for example streets, towns or points of interest), are displayed as shown in the example above. The number of items in the list is displayed (A), and the indicator (B) shows the current position in the list.

- To scroll through the list, one item at a time, touch one of the single arrow buttons (C). (The double arrow buttons [D] scroll one page at a time.)
- To view the remainder of a long entry, touch anywhere on the text. The symbol (E) at the start or end of the line indicates more text.
- To make a selection from the list, use the touch button for the item required (F).

2-4 Introduction to basic screen displays

Function of on-screen control icons

The screen icons used by the system are explained below.



Navigation icon – Indicates the current vehicle position and heading.



Cross-wire icon – This icon is displayed when the map is scrolled to select a destination or point (map cursor location).



Destination icon – Indicates the current route destination.



Next manoeuvre point icon – Indicates the location of the next instruction on the route ahead.



Next turn icon – Shows the action to be taken at the next manoeuvre point on the route ahead. (A typical example is shown.)



North up icon – Indicates that the map is displayed with north to the top of the screen.



Heading up icon – Indicates that the map is displayed with the vehicle heading to the top of the screen. The position of the pointer indicates the direction of north on the map.



Avoid area or point – The left-hand icon indicates an area to be avoided in route calculations. The right-hand icon indicates an avoid point.

Function of on-screen control icons (continued)



Way point icon – Indicates the location of a way point on the map.



Home position icon – Indicates the location on the map, currently stored as the home position.



Stored location icon – Indicates the location of a memory point. This is the default icon used when the point is stored. (If required an icon of your own choice can be selected from the 15 icons available.)



GPS icon – Indicates that insufficient GPS satellite signals are being received for accurate map positioning. The icon is not displayed under normal operation.

2-6 Introduction to basic screen displays

Function of on-screen control buttons

This is a summary of the basic navigation controls. Controls specific to a particular screen or function are explained in the appropriate section of this handbook.

All the navigation controls, except the Navigation button, are touch controls displayed on the screen.

Note: For information on how to operate the touch controls, see the Driver's Handbook, section 1.



Nav Menu button

Displays the Navigation menu, see **Navigation menu** on page 5-3.



Cancel button

Returns to the previous menu, text screen, or to the map display.



NAV button

The Navigation button has the following functions:

- Selects the navigation system.
- While the navigation system is selected, selects the initial map display from any other screen.
- After scrolling, returns to the map display of current vehicle position.

Note:

1. If the navigation system was selected when the ignition was switched off, it will be selected automatically when the ignition is switched on again.
2. When switching back to navigation from another touch-screen system, pushing **NAV** will return to the particular screen being displayed before.



Map orientation buttons

These buttons select the desired map orientation (north or vehicle heading to the top of the screen). The current selection is shown on the map.

Note: Above the 2 miles (4 kilometres) zoom level, only north orientation is available.



Zoom control

Selects the desired map zoom level by touching one of the arrow icons. The currently selected scale is shown. see **Zoom control operation** on page 5-2.

Function of on-screen control buttons (continued)



Audible Repeat button

While under guidance, repeats the last audible instruction and shows the relevant junction diagram (if in range).

Note:

1. If the manoeuvre point has been passed, the audible instruction for the next manoeuvre point will be heard.
2. Repeat is also available while one of the other touch-screen systems is selected (but not during a phone call nor on the TV screen).



Phone button

Calls the phone number currently shown on the screen. Only available when a Jaguar telephone is fitted.

Additional touch buttons

These buttons are displayed after touching the map display.



Home button

Sets a route to the home position. (Only displayed when a home position is set.)



Chg. Route button

Displays the Route Options menu to make changes to the route preference settings. (Only displayed when a route is set.)



Ent. Dest. button

Stores a selected map location as a destination. See **Confirm destination** on page 8-1. (Displayed in place of the **Chg. Route** button, after touching the screen twice within five seconds.)



Store button

Stores a selected map location as a memory point.



POI/POI Off buttons

POI – Selects the quick points of interest function to display POI icons on the map.

POI Off – Deselects the display of icons.

Note: For more information, see **Quick points of interest (POI)** on page 5-11.

Volume adjustment

The volume level of the audible instructions can be adjusted if required. For information on making volume adjustments, see the Driver's Handbook, section 1.

Note: The radio head must be switched on to adjust the volume of the audio instructions. When the radio is switched off, the volume + and – buttons are 'greyed out'.

2-8 Introduction to basic screen displays

Text input

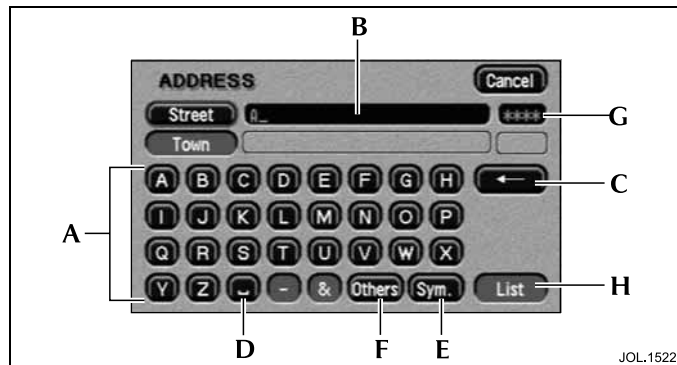

Character input

- Enter the desired name by touching each button in turn (A). The characters entered are displayed on the screen (B). As characters are entered, only the characters available to complete the name (or similar names) are shown highlighted.
 - To delete the last character, touch **Delete** (C).
 - To enter a space, touch **Space** (D).
 - To enter special characters, touch **Sym.** (E).
 - To enter accented characters, touch **Others** (F).
- It is not necessary to enter all the characters. The number of possible names from the characters entered is shown (G). When greater than '9999' then '☆☆☆☆' is shown.
- Touch **List** (H) (when active) to view the available names.

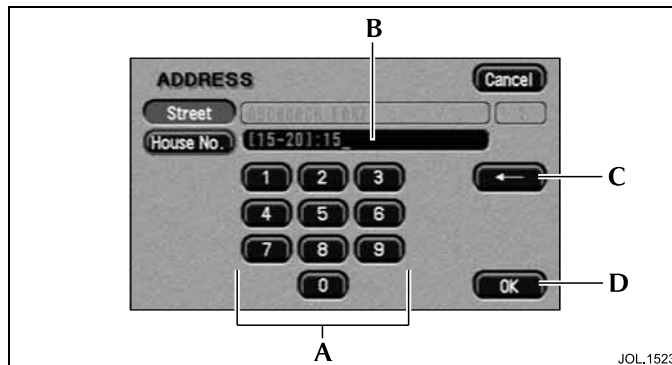

Number input

- Enter the desired number by touching each button in turn (A). The digits entered are displayed on the screen (B).
 - To delete the last digit, touch **Delete** (C).
 - When all the digits have been input, touch **OK** (D). The next screen will be displayed.
- IMPORTANT: Further information on using these screens for specific functions, e.g. destination entry, is given in the appropriate section of this handbook.**

Route setting example

This is a simple example showing how to use the basic features of the system to set a route. It describes each screen in turn and explains how to use the controls. For information relating to the other features of the system, see the relevant section in this handbook.

Note: Before using the system, check that the correct map DVD is loaded, see **Loading the map DVD** on page 1-6.

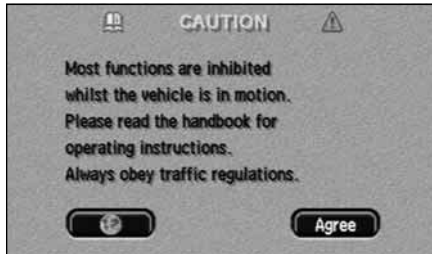

JOL1516

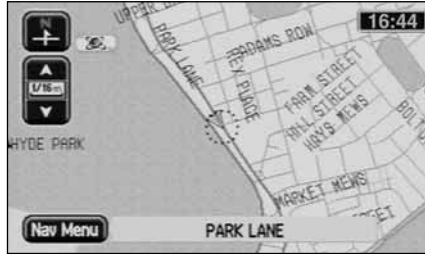

JOL1524



JOL1525

1 Selecting the system

Note: The ignition must be switched on (position '1').

To select the navigation system (if necessary), push the **NAV** button on the bezel of the touch-screen panel. The road safety caution will be displayed. To use the system, read the caution and touch **Agree**.

2 Map display

The initial map screen showing the current vehicle position is displayed.

- Touch **Nav Menu** to select the Navigation menu.

3 Navigation menu

The Navigation menu is the top level menu of the system, and shows the main functions that are available.

- Touch **Destination Entry** to select the Destination Entry menu.

3-2 Route setting simple example

Route setting example (continued)



JOL.1526

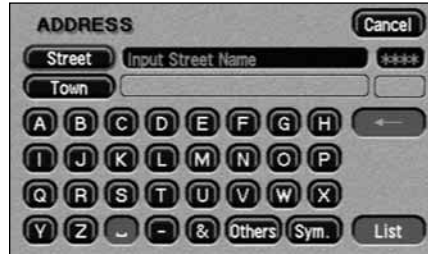

JOL.1527

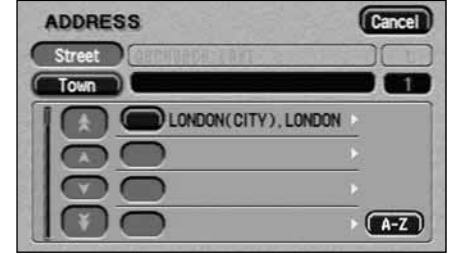

JOL.1528

4 Destination entry menu

The Destination Entry menu shows the options available for setting a route. The map inset shows the currently selected area, which the system will use when searching for destination addresses.

- Touch **Address** to enter the destination details for the desired route.

Note: If your route destination is not within the area highlighted on the map, another search area must be selected, see **Changing search area** on page 6-2.

5 Enter street name

- Enter the street name by touching the buttons required.

For more information, see **Character input** on page 2-8.

- When sufficient characters have been entered, touch **List**.

The list of possible streets from the characters entered is displayed.

- Select the street required.

Note: In this example the street name is entered first. Addresses can be entered in other ways, e.g. town name first.

6 Select town

The screen shows the list of towns where the street name entered occurs.

- Select the town required.

Note:

1. If there is only one town match, this step is omitted.
2. If more than 100 matches are found, the alpha keyboard screen is displayed automatically, to allow the desired town name to be entered.
3. If a less than 100 matches are found, the alpha keyboard screen may be displayed manually by touching the **A-Z** button.
4. For more information about the list, see **Town name lists** on page 1-5.

Route setting example (continued)

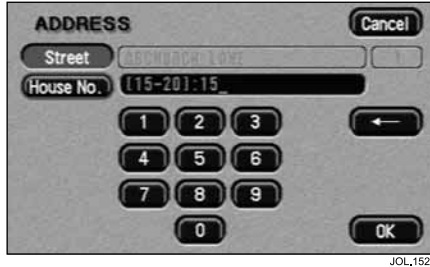

JOL1529

7 Enter house number

- Enter the house number by touching the buttons required.

For more information, see **Number input** on page 2-8.

- When all the digits have been entered, touch **OK**.

Note:

1. If a list of house number ranges is displayed, select the range applicable.
2. If the street does not have house numbers, or the house number is not known, just touch **OK**. The mid-point of the street will be used as the destination.

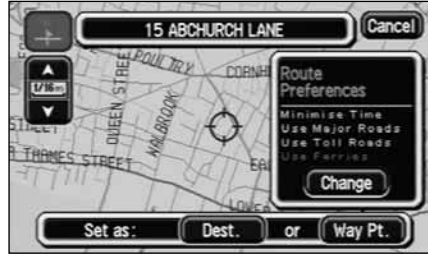

JOL1530

8 Confirm destination

The map screen showing the destination details, and the current route settings is displayed.

- Touch **Dest.** to confirm as a destination.

The screen shows 'Calculating Route' while the route is calculated.

Note: For information on using way points, see **Route calculation** on page 8-1.

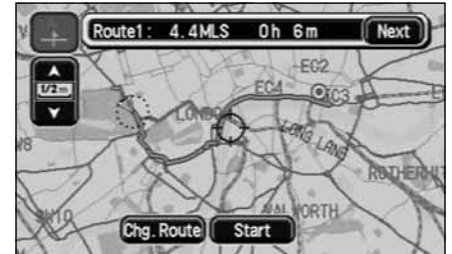

JOL1531

9 Start guidance

When the route calculation has been completed, the map display shows the entire route and the route information at the top of the screen.

- Touch **Start** (or commence driving).

Alternative routes

The system will also calculate at least one alternative route (where possible). The alternative route(s) can be viewed and selected in place of the original route if required.

- To view an alternative route, touch **Next**.

3-4 Route setting simple example

Route setting example (continued)

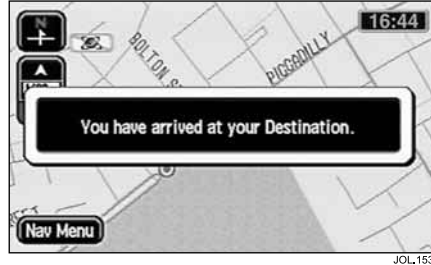
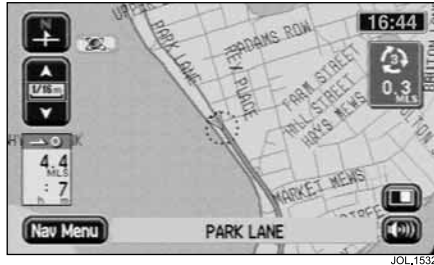

10 Route guidance



WARNING:

Only operate, adjust or view the system when it is safe to do so.

After touching **Start**, the initial map screen while under guidance is displayed. The route is shown highlighted, with the current road name shown in the text area at the bottom of the screen.

Drive away, following the voice guidance given by the system. Continue to follow the voice guidance until the end of the route is reached.

11 Arrival at destination

When the vehicle reaches the end of the route, the screen shows the destination address details. Arrival at the destination is also confirmed by voice guidance. The system is now ready for further use.

Main features of the system

Stored locations

These are map locations (memory points) that you can store in the system memory with a personalised nametag, e.g. Doctor, or Office, for subsequent selection as a route destination or way point. If the vehicle is fitted with the voice activation system, voice nametags can be used as well.

There are several methods you can use to create a memory point, e.g. entering an address, or selecting a point of interest (POI) from the database.

Way points

Way points can be used to divide a route into a number of sections, and are entered in a similar manner to the destination. As way points are entered, they are added to a list, up to a maximum of five way points.

Way points are visited in the order in which they appear in the way points list, and the order can be changed if required. After each way point has been visited, it is deleted from the way points list automatically.

Avoid areas

An area on the map can be selected as an avoid area, for example, a known area of heavy traffic. Up to 10 areas can be selected. Routes will then be calculated avoiding the area(s) selected, except where an alternative is not possible.

Points of interest (POI)

This is a database of useful names and addresses held on the map DVD, e.g. airports, hotels and restaurants. The information can be displayed and sorted by category. A POI can be selected from the list and used as a route destination or way point. Where the POI information includes a phone number, this can be called by touching the phone icon.

Quick points of interest

When this feature is selected, the map screen shows the location of all the points of interest in a particular category. Each POI location is indicated by displaying the appropriate POI icon. The category to be displayed is selected from a list of six popular categories. These can be changed to categories of your own choice.

Voice guidance

One or more audible instructions and/or chimes will be heard as the vehicle approaches each manoeuvre point along the route. The instruction and chime are repeated as the vehicle reaches the manoeuvre point. Voice guidance can be turned off if required, and will be muted automatically if a phone call is in progress.

Screen guidance

Screen guidance is provided by means of the map display, and an overlay (the guidance screen) which shows one of the following: junction diagram, turn arrow, or turns list. Various combinations of these features can be selected, see **Display options** on page 5-10. As the route is followed, the current street name, estimated time (if selected) and distance remaining to the end of the route are displayed.

For further information, see **Screen types** on page 8-9.

4-2 Quick reference

Frequently used functions

The starting position for all these functions is the map screen showing the current position of the vehicle. If any other screen is shown, push the **NAV** button to display the map screen.

Getting started

Entering a destination by address

Nav Menu → Destination Entry → Address → enter the address details required → **Dest.** → **Start**.

Entering a destination to a town centre

Nav Menu → Destination Entry → Address → enter the town name required → **Town Centre** (icon) → **Dest.** → **Start**.

Using a point of interest as a destination

Nav Menu → Destination Entry → Point of Interest → select the point required → **Dest.** → **Start**.

Storing a location as the home position

Nav Menu → Stored Locations → Home → **Add** → enter the address details required → **OK**.

Adding a memory point

Nav Menu → Stored Locations → Memory Point → **Add** → enter the address details required → **OK**.

Options available while driving

Setting a destination to the home position

Touch the screen → **Home**. (Only available when a home position is set.)

Storing a map location as a memory point

Scroll the screen → **Store**.

Displaying point of interest icons

Touch the screen → **POI** → select a POI category.

Changing the map heading (north up/heading up)

Touch the Map Orientation button.

Note: Not available if scale is greater than 2 miles or 4 km.

Options available only with a route set

Cancelling guidance

Nav Menu → Route Options → Cancel Guidance.

Repeating voice guidance

Touch the **Repeat** button.

Changing route preferences

Touch the screen → **Chg. Route** → Route Preferences → select the preferences required.

Menu structure

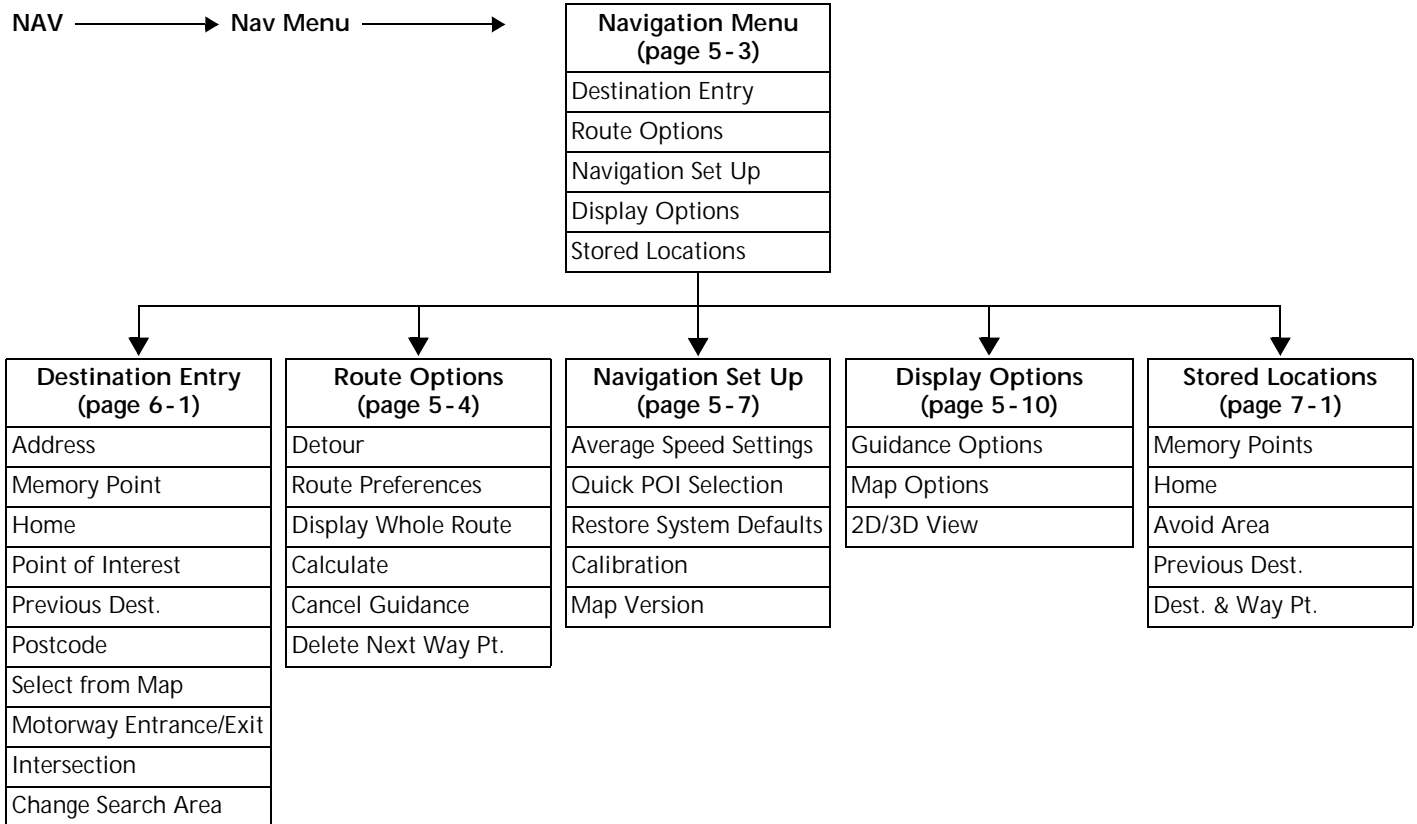

4-4 Quick reference

POI category list

Automotive

- Automobile Club
- Petrol Station
- Parking Garage
- Car Park
- Jaguar Dealers*

Community

- Town Hall
- Community Centre
- Convention/Exhibition Cent.
- University/College
- Hospital

Entertainment & Recreation

- Theme/Amusement Park*
- Casino
- Cinema
- Golf Course
- Ice Skating Rink
- Marina
- Museum
- Nightclub
- Park/Gardens*
- Theatre
- Recreation
- Ski Resort
- Sports Centre
- Sports Complex
- Tourist Attraction*
- Vineyard

Restaurant

- All
- American
- Chinese
- Continental
- French
- Italian
- Japanese
- Mexican
- Seafood
- Other

Shopping

- Shopping
- Supermarket

Travel

- Airport*
- Bus Station
- U'grnd/Commuter Rail Stn.
- Ferry Crossing
- Historical Monuments
- Hotel
- Park and Ride
- Hire Car Agency
- Service/Rest Area
- Tourist Information
- Train Station

Other

- Town Centre

* All search areas

Initial map display

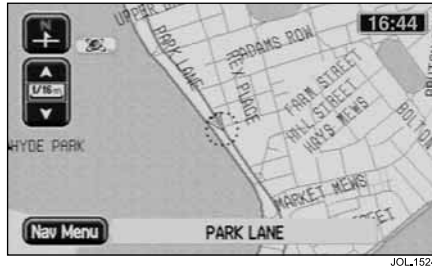

JOL1524

After touching **Agree**, on the Road safety Caution screen, the initial map screen showing the vehicle location is displayed, with the current road name shown in the text area at the bottom of the screen.

Distance units

Distances are shown on the screen, and given in voice guidance, either in Imperial units (miles) or in Metric units (kilometres and metres). For information on changing the unit selection, see the Driver's Handbook, section 1.

Touch controls

The touch controls displayed on the initial map screen are as follows:



Nav Menu button

Displays the Navigation menu, see **Navigation menu** on page 5-3.



Map orientation buttons

These buttons select the desired map orientation (north or vehicle heading to the top of the screen). The current selection is shown on the map.

Note: Above the 2 miles (4 kilometres) zoom level, only north orientation is available.



Zoom control

Selects the desired map zoom level by touching one of the arrow symbols. The currently selected scale is shown. See **Zoom control operation** on page 5-2.



End call button

Ends a phone call. Only displayed while a phone conversation is in progress and if a Jaguar telephone is fitted.

5-2 Menu structure

Initial map display (continued)

Additional touch buttons

These buttons are displayed after touching the map display.

Ent. Dest.

Ent. Dest. button

Stores a selected map location as a destination. See **Confirm destination** on page 8-1. (Displayed after touching the screen twice within five seconds.)

Store

Store button

Stores a selected map location as a memory point.

POI

POI button

Selects the quick points of interest function to display POI icons on the map. For more information, see **Quick points of interest (POI)** on page 5-11.



Zoom control operation

When the control is touched, the scale indicator is shown on the screen.

The scale markings shown on the indicator are: $\frac{1}{32}$, $\frac{1}{2}$, 4, 128 miles (50 m, 1 km, 8 km, 256 km).

The zoom control can be used in a number of ways as follows:

- Touch and hold one of the arrow buttons. The map is redisplayed at each zoom level in turn.
- Touch one of the arrow buttons repeatedly. The map is only redisplayed at the final zoom level.
- Touch one of the segments of the scale indicator. The map is redisplayed at the zoom level selected.

Navigation menu



The Navigation menu is the top level menu of the system, showing the functions that are available:

Destination Entry – see page 6-1.

Route Options – see page 5-4.

Navigation Set Up – see page 5-7.

Display Options – see page 5-10.

Stored Locations – see page 7-1.

- Select the menu item required.



Audible instructions

The highlighted icon shows whether the setting for voice guidance is currently On or Off.

- To change the voice guidance setting, touch the icon required.

Functions available on the move

For safety reasons, only certain functions are available while the vehicle is on the move.

5-4 Menu structure

Route options menu

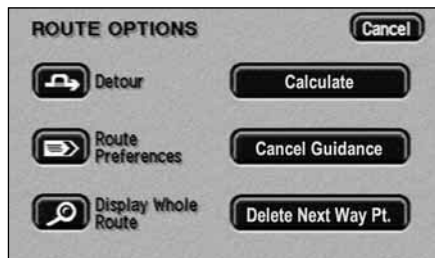

The menu shows the route options available:

Detour

Route Preferences

Display Whole Route

Calculate

Cancel Guidance

Delete Next Way Pt.

- Select the menu item, or touch the button for the option required.

These options are described as follows:

Detour

While driving under guidance, this feature allows you to make a detour from the calculated route for a specified distance. The screen shows the detour distance settings available for residential roads and motorways. The current selections are shown highlighted.

Residential: 1, 2, 3, 4, 5, 10, 15 miles (or kilometres).

Motorway: 5, 10, 15, 20, 25, 50, 100 miles (or kilometres).

- Touch the appropriate screen items to change the detour settings as required.

Route detour

- Touch the **Detour** button.

The route ahead is recalculated using the current detour distance settings.

Alternative route

- Touch the **New Route** button.

The system uses different combinations of the route preference settings to calculate an alternative route (where possible).

Note: The detour settings are only used when you touch **Detour** and only apply to the current route.

Route preferences

The screen shows the route preferences available, with the current settings highlighted.

Minimise Time/Dist. – Time/Dist.

Use Major Roads – Yes/No.

Use Toll Roads – Yes/No.

Use Ferries – Yes/No.

- To select a route preference, touch the button for the setting required.
- Touch **Store Setting** to apply the new settings.
- Touch **Calculate** to apply the new settings and calculate a route.
- Touch **Cancel** to keep the old settings.

Note: The system will use your route preference settings wherever possible. However in some circumstances, to calculate a satisfactory route, one or more of the alternatives may have to be used.

Route options menu (continued)



JOL1577

1 Display route

After selecting Display Route, the screen shows the whole route, with the total route distance, and estimated travelling time displayed at the top of the screen. Where the route includes a ferry crossing, a ferry icon is shown.

- To view the destination, touch **Dest Map**.
- To view the turn list, touch **Turn List**.

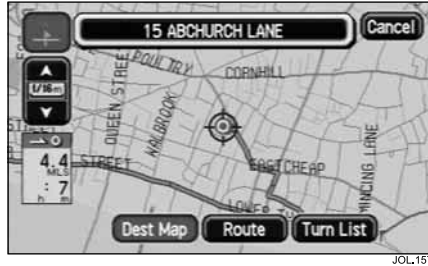

JOL1578

2 End of route display

After touching **Dest Map**, the screen shows the last portion of the route, with the destination address displayed at the top of the screen.

- To return to the whole route display, touch **Route**.
- To view the turn list, touch **Turn List**.



JOL1579

3 Turn list

After touching **Turn List**, the first portion of the route turn list is displayed.

- To view the rest of the entries, scroll the list as required.
- To recalculate the route, touch **Reroute**. See **Calculating the route** on page 8-1.

Avoid point/area – See next page.

5-6 Menu structure

Route options menu (continued)

Turn list (continued)

Avoid point/area – Any point on the route can be avoided if required.

- Touch the **Avoid** button next to the required entry in the turn list.

The map screen is displayed showing the location and address of the selected point.

- Scroll the map to adjust the location if required.
- Use the **Enlarge** and **Reduce** buttons to create an avoid area if required.
- Touch **OK** to confirm.

Note:

1. The points or areas selected in this way are only avoided for the current route. Permanent avoid areas are created from the Store Avoid Area menu, see **Avoid area** on page 7-5.
2. In some circumstances, to calculate a satisfactory route, it may not be possible to avoid all the selected points or areas.

Calculate

This is a quick way to start a route calculation after making changes to the route preferences. For more information, see **Route calculation** on page 8-1.

Note: The route will be calculated using the destination and/or way point addresses previously entered.

Cancel guidance

The map showing the whole route is displayed.

- Touch **Yes** to cancel the route.

Delete next way pt.

Deletes the next way point (if way points have been chosen) from the route which is currently being followed.

Navigation set up menu

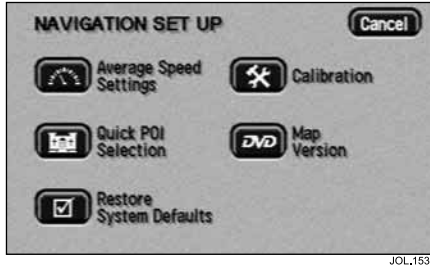

The menu shows the setup options available:

Average Speed Settings

Quick POI Selection

Restore System Defaults

Calibration

Map Version

- Select the menu item required.

These options are described as follows:

Average speed settings

The screen shows the current average speed settings. Speeds can be selected in the range from 5 mph (5 km/h) to 150 mph (240 km/h). The default settings are:

Residential Road: 20 mph (30 km/h).

Main Road: 40 mph (60 km/h).

Motorway: 60 mph (100 km/h).

- Select the average speeds required using the touch arrows.
- Touch **OK** to apply the new settings.
- Touch **Default** to apply the default settings if required.

Note: These settings do not affect route calculation, they are only used in displaying the time to destination. Choose your own usual speeds, so that the time shown matches your own driving style as closely as possible.

Quick POI selection

The six default quick POI categories, can be changed as required. The screen shows the icons for the six current categories.

- Select the category icon that you wish to replace.

The screen shows the full list of POI categories.

- Select the new category required from the list.

The screen shows the new selection of category icons.

- Repeat for another category icon if required.
- Touch **OK** to apply the new settings.

5-8 Menu structure

Navigation set up menu (continued)

Restore system defaults

The default settings are as follows:

Guidance Voice: On.

Search Area: Belgium.

Route preferences:

- Minimise Time/Distance: Time.
- Use Major Roads: Yes.
- Use Toll Roads: Yes.
- Use Ferries: No.

Detour:

- Residential Road: 4 miles (4 km).
- Motorway: 20 miles (20 km).

Average speed settings:

- Residential Road: 20 mph (30 km/h).
- Main Road: 40 mph (60 km/h).
- Motorway: 60 mph (100 km/h).

Quick POI categories:

- Petrol.
- Parking.
- All Restaurant.
- Hotel.
- Shopping Centre.
- Golf Course.

Display Options:

- Map Screen: Split Screen.
- Guidance Screen: Turn Arrows.
- Time To Destination: Show.
- Message Centre Guidance: On.
- To select the complete set of default settings, touch **OK**.

Calibration

See next page.

Map version

The screen shows the issue date of the map DVD currently loaded.

Navigation set up menu (continued)

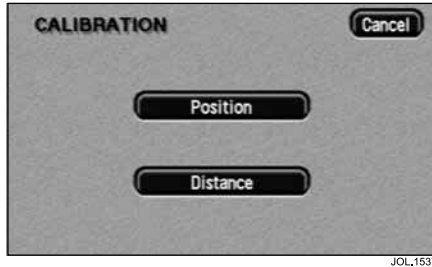

Calibration

Sometimes the vehicle position may not be correct. This can occur, for example, if the vehicle has been moved on a trailer or by ferry. If the new position is not found automatically by the system, it can be corrected by using the calibration procedures (Position first).

- Touch **Position** to adjust the vehicle position. See **Position procedure** on this page.
- Touch **Distance** to recalibrate the system.

The screen briefly shows 'Distance Calibration is in Progress'. Calibration is carried out during normal driving. No notification is given that distance calibration has been completed.

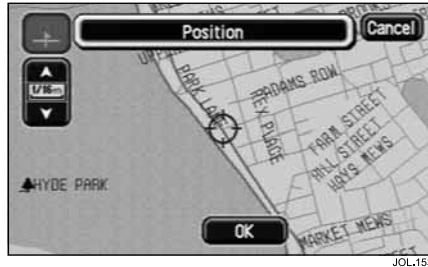

Position procedure

The map showing the current vehicle position is displayed.

- Scroll the map until the navigation symbol (vehicle position) is in the correct geographical location.
- Touch **OK** to confirm the new position and display the map screen for heading adjustment.

Note: If a route is set, a new route calculation will be carried out.



Position (heading)

The map screen showing the heading adjustment arrows is displayed.

- Adjust the vehicle heading using the arrows (clockwise or anticlockwise), until the navigation symbol is shown in the correct alignment.
- Touch **OK** to confirm the new heading.

Display options

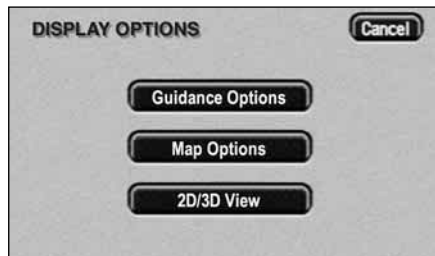

JOL1933

The screen shows the display options available, with the current selections highlighted:

Guidance Options

Map Options

2D/3D View

Guidance options

Turn Arrows – When set to Turn Arrows, the guidance screen overlay shows the on-route arrow and next turn icon. Before each manoeuvre point, the next junction diagram is displayed automatically.

Turn List – When set to Turn List, the guidance screen overlay shows the current portion of the route turn list. Before each manoeuvre point, the next junction diagram is displayed automatically.

2D/3D View

Selects 2D or 3D views for the main maps and guidance overlays.

See **Selecting 2D/3D views** on page 5-15.



JOL1935

Map options

The options that can be set are:

Memory Point Icons – Show/Hide.

Time To Destination – Show/Hide.

Message Centre Guidance – On/Off – provides supplementary information, displayed on the vehicle message centre, located beneath the speedometer and tachometer.

Low Fuel Warning – On/Off – displays the petrol station icons (see below) automatically, when the fuel level is down to the normal low level warning.



Petrol station icon.

Quick points of interest (POI)



JOL1541

Selecting a category

- Touch the Initial Map display, then touch the **POI** button. The screen shows the six categories currently selected for quick points of interest.
- Select a POI category.

The map screen is displayed with POI icons. See **POI icon display** on this page.

Other categories

You can also select from the complete list of POI categories.

- Touch **List Categories** and select a category from the list displayed.

Local POI search

This selects the points of interest in all categories within 20 miles (32 kilometres) of the vehicle.

- Touch the **All Local POI's** button.



JOL1542

POI icon display

After selecting a category, the map display shows the location of each POI in the selected category, indicated by the appropriate POI icon.

- For information about a particular POI, touch the desired POI icon. See **POI information** on this page.

Note: POI icons can only be displayed up to the ½ mile (1 km) zoom level.

5-12 Menu structure

Quick points of interest (POI) (continued)

Next button

If some POI locations are very close to one another, it may not be possible to select a particular icon to display the information.

- Touch **Next** (when active) to select one of the icons in a group and display its information. Repeat for the other icons as required.



JOL1543

POI information

After touching a POI icon, the name of the selected POI is displayed at the top of the screen.

POI details

- Touch **Info.** to display the details of the selected POI.

The details include Name, Address, Town and Telephone number.

The phone number can be called by touching the phone icon (if a Jaguar telephone is fitted).

Destination entry

- From the POI icon map display, touch **Ent. Dest.** to store the POI location as a destination.

The destination details are displayed for confirmation of the address, see **Confirm destination** on page 8-1.

Changing the categories

Any of the six categories can be changed from the Navigation Set Up menu, see **Quick POI selection** on page 5-7.

Cancelling POI icon display

If the display of POI icons is no longer required, they can be turned off as follows:

- Touch the map screen to display the additional touch buttons.
- Touch **POI Off** to cancel the display of POI icons on the map.

Memory points



The procedure for using memory points is functionally the same as for using the Quick Points of Interest.

The use of Memory Points is described in detail, see **Memory points** on page 7-2.

With Mem. Points set to ON, the map display shows the location of all memory points stored.

- For information about a particular memory point, touch the desired memory point icon.

After touching the memory point icon, the name of the selected memory point is displayed at the top of the screen.

Memory point details

- Touch **Info.** to display the details of the selected memory point.

The details include name, position and phone number.

The phone number can be called by touching the phone icon, if a Jaguar telephone is fitted.

The memory point details can be edited, see **Location details** on page 7-2.

Cancelling icon display

If the display of Memory Point icons is no longer required, they can be turned off as follows:

- Touch the map screen to display the additional touch buttons.
- Touch **Memory Point Off** to cancel the display of icons on the map.

5-14 Menu structure

Perspective views

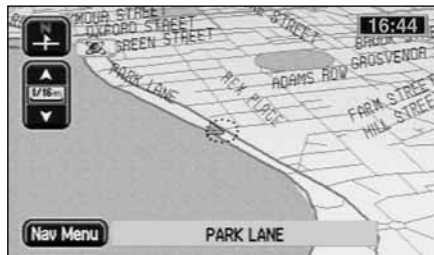

Initial map display

In addition to the normal display, the map screen can also be displayed as a 3D (perspective) view. A typical perspective view map screen with no route set is shown above. All the usual on-screen features and touch controls are available when using perspective map display.

Selecting the type of display

The type of map display is selected from the Navigation Set Up menu. See **Selecting 2D/3D views** on the following page.



Scrolling the map

When scrolling the map in perspective view, the map orientation adjustment arrows are displayed. This allows the map heading to be changed independently of the vehicle heading.

- To change the map orientation, touch either of the adjustment arrow buttons as required.

Note: After touching one of the adjustment arrows, the map is displayed heading up.

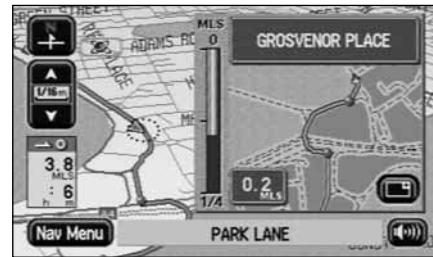

Map display under guidance

A typical perspective view map screen while under guidance is shown above. Any combination of 2D and 3D views can be selected for the main map display and the guidance screen overlay. See **Map dimension** on the following page.

Using perspective view



Selecting 2D/3D views

On the Display Options screen, select **2D/3D View**. A map is displayed showing the options available:

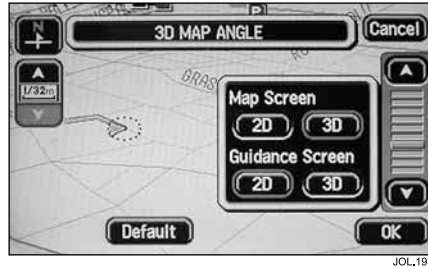

Map dimension

Any combination of 2D and 3D views can be selected for the main map display and for the guidance screen overlay.

- To select, touch the **2D** or **3D** buttons as required.
- Touch **OK** to apply the new settings.

3D map angle

When **3D** is selected the screen shows the map display in perspective view with the angle adjustment control shown.

The perspective angle can be changed by using the adjustment control displayed on the screen.

- To change the angle, touch either of the adjustment arrow buttons as required.
- Touch **OK** to apply the new setting.

Preset angle setting

A preset perspective angle setting is also available.

- To select the preset setting, touch **Default**.
- Touch **OK** to apply the new setting.

Note: The map zoom level and heading can be changed if required, using the touch controls displayed.

Destination entry menu

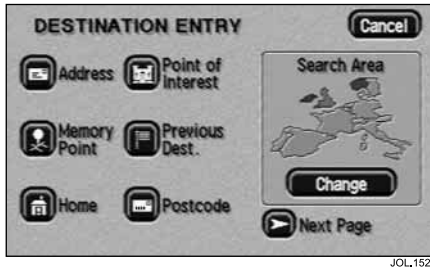

The menu shows all the methods available for route setting:

Address

Memory Point

Home

Point of Interest

Previous Dest.

Postcode

All these methods are described in the following pages.

Next/previous page

The Destination Entry menu consists of two pages.

- To select a menu item that is not being displayed, touch **Next Page** or **Prev. Page**.

The second page contains the following methods available for route setting:

Select from Map

Motorway Entrance/Exit

Intersection

These methods are described in the following pages.

Search area

To reduce the time taken to calculate a route, the map database is divided into a number of regions. When setting a route, the destination (or way point) being entered must be in the currently selected search area. See **Changing search area** on page 6-2.

Using the destination entry menu

The Destination Entry menu is used for both destination and way point entry. (Way points and the destination can be entered in any order.)

- Select an item from the menu. (For example, to use a point of interest as the destination, select **Point of Interest**.)

6-2 Route setting

Destination entry menu (continued)

Changing search area

Also, see **Search area/country change** on page 1-9.

- To change the search area, touch **Change**.

The current area is shown highlighted on the map, and the countries it covers are listed at the bottom of the screen.

- From the list displayed, select the touch button required for the new area, see the following list.

The screen shows the new area highlighted and the list of countries covered.

	Area	Countries
A	Austria	Austria
B	Belgium	Belgium
CH	Switzerland	Switzerland, Liechtenstein
D	Germany	Germany
DK	Denmark	Denmark
E	Spain	Spain, Andorra
F	France	France, Monaco, Andorra
GB	Great Britain	England, Scotland, Wales
I	Italy	Italy, San Marino, Vatican City
L	Luxembourg	Luxembourg
NL	Netherlands	The Netherlands
P	Portugal	Portugal
S	Sweden	Sweden

Changing search area in Australia

To change the search area, touch **Change**.

The current area which is selected is shown highlighted on the map.

- From the three buttons displayed, select the button required for the new area.

The screen shows the new area highlighted.

By address



JOL1527

1 Street entry

After selecting Address from the Destination Entry menu, the alpha keyboard screen is displayed, showing 'Input Street Name'.

- Enter the street name required, see **Text input** on page 2-8.
- Touch **List** to display the list of possible streets.

The list of possible streets from the characters entered is displayed.

Streets and villages with hyphenation, dots, etc. in their names (e.g. St. Bartholomews) will display both with and without punctuation, to aid the user to choose the correct one.

- Select the street required.

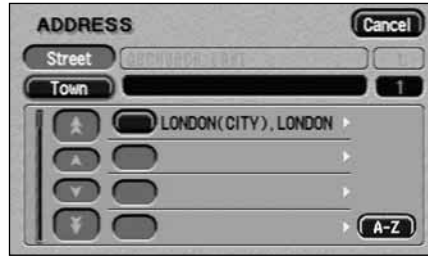

JOL1528

2 Select town

The screen shows the list of towns where the street name entered occurs.

- Select the town required.

Note:

1. If there is only one town match, this step is omitted.
2. If a large number (more than 100) of matches is found, the alpha keyboard screen is displayed automatically, to allow the desired town name to be entered.

3. If a less than 100 matches are found, the alpha keyboard screen may be displayed manually by touching the **A-Z** button.
4. For more information about the list, see **Town name lists** on page 1-5.

6-4 Route setting

By address (continued)

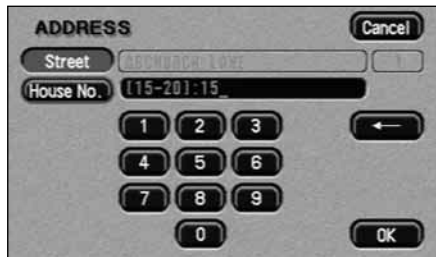

3 House number entry

The number pad screen is displayed, showing the house number range for the street selected.

- Enter the house number required and touch **OK**, see **Number input** on page 2-8.

The destination details are displayed for confirmation of the address, see **Confirm destination** on page 8-1.

Note:

1. If a list of house number ranges is displayed, select the range applicable.
2. If the street does not have house numbers, or the house number is not known, just touch **OK**. The mid-point of the street will be used.

Order of address entry

The example on the previous page shows how to enter an address with the street name first, followed by selecting the town, and finally the house number. You should find this the best method in most cases, however other methods are possible.

Entering town name first

In this example, the town name is entered first.

- From the Destination Entry menu, select **Address**.

The alpha keyboard screen is displayed, showing 'Input Street Name'.

- Touch the **Town** button.

The screen now shows 'Input Town Name'.

- Enter the town (or district) name required, see **Text input** on page 2-8.
- Touch the **List** button.

The list of towns possible from the characters entered is displayed.

- Select the town required.

The alpha keyboard screen is displayed, showing 'Input Street Name'.

- Enter the street name required, see **Text input** on page 2-8.
- Touch the **List** button.

The list of streets possible from the characters entered is displayed.

- Select the street required.

The number pad screen is displayed, showing the possible house number range for the street selected.

- Enter the house number required, see **Number input** on page 2-8.
- Touch the **OK** button.

The destination details are displayed for confirmation of the address, see **Confirm destination** on page 8-1.

By address (continued)

Entering town names

When entering the name of a town in another country, the name must be entered according to the usual spelling in the country concerned.



Town centre button

When displayed after a town name, this touch button selects the town centre as a destination.



List button

The button becomes active when the characters entered reduces the possible entries to a small enough number. (The list is displayed automatically when the number of entries reduces to four or less.)

Address entry messages

While entering an address, you may encounter one of the following messages:

1. 'House Number not Found.
Show Mid-Point of Street? Yes/No.'
 2. 'The address does not exist.
Show centre of this street? Yes/No.'
 3. 'Street Found in Many Towns.
Please Input the Town Name.'
- Select one of the touch buttons (**Yes** or **No**) or enter a town name, as required.

6-6 Route setting

Using a memory point

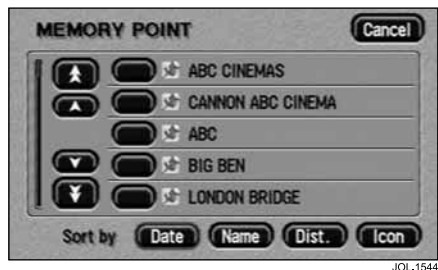

Memory point

After selecting **Memory Point** from the Destination Entry menu, the screen shows the list of stored memory points.

- Select the item required.

The destination details are displayed for confirmation of the address, see **Confirm destination** on page 8-1.

Note:

1. The list can be sorted by Date, Name, Distance or Icon by touching the button required.
2. When sorting by Icon, the icons are listed in the order they appear on the icon selection screen (left to right, top row first). see **Icon list** on page 7-3.
3. While driving, the list scrolling function is not active. You can only choose from the items shown at the top of the list.
4. To assist selection of memory points while driving, frequently used points can be given names starting with the letter 'A'. If the list is then sorted by Name, these points will appear at the top.

Using the home position

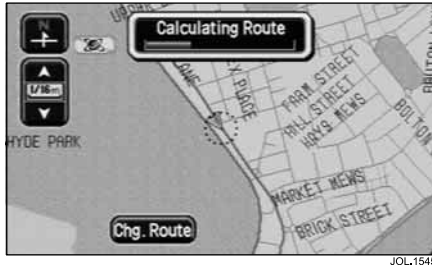

Home

After selecting **Home** from the Destination Entry menu, a route is calculated to the stored home position.

The location of the home position is displayed, and the screen shows 'Calculating Route' while the route is being calculated.

Note: If a home position has not been entered, this function cannot be selected.

6-8 Route setting

Using a point of interest (POI)

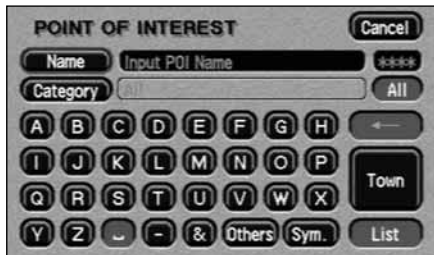

JOL1546

Note: If entering a POI name results in too many matches being listed, try entering the town name first. If you do not know the name of the POI you want, try selecting a POI category. These methods are described as follows:

Entry by POI name

After selecting **Point of Interest** from the Destination Entry menu, the alpha keyboard screen is displayed, showing 'Input POI Name'.

- Enter the POI name required, see **Text input** on page 2-8.
- Touch **List** to display the list of matching points of interest. See **POI list** on page 6-11.
- Select the POI required.

The map location of the POI is displayed, see **Confirm destination** on page 8-1.



JOL1547

Entry by town

If a town name is entered first, the points of interest listed will be restricted to that town.

- From the Input POI Name screen, touch **Town**.

The screen now shows 'Input Town Name'.

- Enter the town name required, see **Text input** on page 2-8.
- Touch **List** to display the list of possible towns.
- Select the town required.

The Input POI screen is displayed again.

- Enter the POI name required. See **Entry by POI name** on this page.

Using a point of interest (POI) (continued)

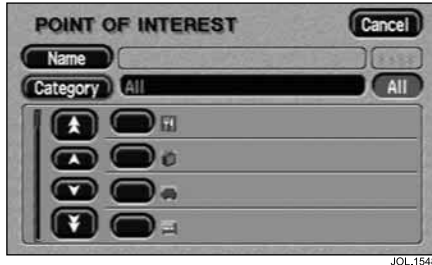

The screen now shows the list of sub-categories under the selected main category.

- Select the sub-category required.

The Input POI Name screen is displayed again.

- Enter the POI name required.
See **Entry by POI name** on this page.

Entry by category

If a POI category is selected first, the points of interest listed will be restricted to that category.

- From the Input POI Name screen, touch **Category**.

The screen shows the list of main POI categories.

- Select the category required.

6-10 Route setting

Using a point of interest (POI) (continued)

Other selection methods

The examples on the previous page show the three basic methods of searching the POI database, i.e. POI name only, town before POI name, and category before POI name. You can refine the search even further, as described in the following examples.

Town followed by category

In this example the order is: town, followed by category, then POI name.

- From the Input POI Name screen, touch **Town**.
- Enter the town name required.
See **Entry by town** on page 6-8.

The Input POI Name screen is displayed again.

- From the Input POI Name screen, touch **Category**.
- Select the category and sub-category required. See **Entry by category** on page 6-9.

The Input POI Name screen is displayed again.

- Enter the POI name. See **Entry by POI name** on page 6-8.

Category followed by town

In this example the order is: category, followed by town, then POI name.

- From the Input POI Name screen, touch **Category**.
- Select the category and sub-category required. See **Entry by category** on page 6-9.

The Input POI Name screen is displayed again.

- From the Input POI Name screen, touch **Town**.

The screen now shows 'Input Town Name'.

- Enter the town name required.
See **Entry by town** on page 6-8.

The Input POI Name screen is displayed again.

- Enter the POI name required.
See **Entry by POI name** on page 6-8.

Town centres

The POI database also holds town centre locations. To select a town centre, proceed as follows:

- From the Input POI Name screen, enter the town name required in the **Name** text area. (Do not select the **Town** button.)
- Touch **List** to display the list of matches.
- For the town centre, select the entry showing the town name only.

The map is displayed showing the town centre location, see **Confirm destination** on page 8-1.

Note: In some cases, more than one town centre location may be listed.

Using a point of interest (POI) (continued)

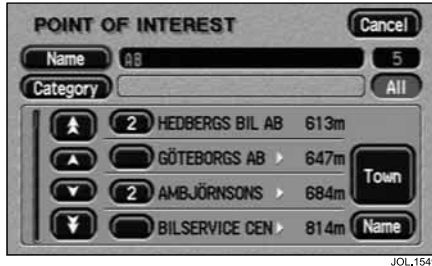

POI list

The screen shows the list of points of interest found in the database search.

- Select the POI required.

The map showing the location of the selected POI is displayed.

Note: Some entries in the list may have a further sub-list following.

POI details

- To view the details of the selected POI, touch **Info.** from the map display.

The details include Icon, Name, Position and Tel.

Telephone number – The phone number can be called by touching the phone icon (if a Jaguar telephone is fitted).

List sorting

The list can be sorted by Name or Distance, but is always sorted by name when first displayed.

The illustration currently shows the list sorted by distance.

- Touch the **Name** button at the lower right hand corner of the screen, to sort the list by name. This button toggles between the Name and Distance (**Dist.**) function depending on which list is displayed.

Note: When the list is sorted by distance, the distance shown is the straight line distance from the current vehicle location.

Categories/sub-categories

The POI database is divided into a number of categories. Each main category is further divided into a number of sub-categories, see **POI category list** on page 4-4.

The first entry in the list of Restaurant sub-categories, is 'All'. This selects all of the Restaurant sub-categories.

To narrow the search, touch the **Town** button. This will display the alpha keyboard, to allow the desired town name to be entered.

Search area

When searching the database, only points of interest in the current search area are included, except for the sub-categories marked 'All search areas' in the POI category list.

6-12 Route setting

Using a point of interest (POI) (continued)



List button

The **List** button becomes active, when the characters entered reduce the possible entries to a small enough number. (The list is displayed automatically when the number of entries reduces to four or less.)

You can also select **List** (when active) without entering a POI name. All the relevant points of interest will be displayed, e.g. in a selected town or category.



All button

The **All** button returns to searching all categories after selecting one category.

POI entry messages

While searching for points of interest, you may encounter one of the following messages:

1. 'There are no POI's in this Category.'
2. 'No POI's Found in this Town.'

Using a previous destination



Previous starting point

If the **Previous Starting Point** button is selected, the location used for the destination will be the starting point of your last journey, irrespective of whether you were driving under guidance or not.

Previous destination

After selecting **Previous Dest.** from the Destination Entry menu, the screen shows the list of stored previous destinations.

- Select the item required.

The destination details are displayed for confirmation of the address, see **Confirm destination** on page 8-1.

Note: While driving, the list scrolling function is not active. You can only choose from the items shown at the top of the list.

6-14 Route setting

Using a postcode

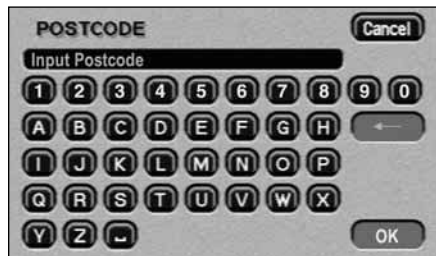

JOL1931

Postcode

Using a postcode is not available in Australia.

After selecting **Postcode** from the Destination Entry menu, the alpha-numeric keyboard screen is displayed showing 'Input Postcode'.

- Enter the postcode characters required, including any spaces and punctuation as used in reality, and touch **OK**, see **Text input** on page 2-8.

The mid-point of the postcode area is displayed, see **Confirm destination** on page 8-1.

Post code formats

The following, is a list of countries where the navigation system provides full postcode entry:

- Austria
- Belgium
- Denmark
- France
- Germany
- Italy
- Luxembourg
- Spain
- Switzerland
- United Kingdom

The following, is a list of countries where the navigation system provides reduced postcode entry:

- Netherlands:
The four numeric digits only
e.g. 4817.
- Sweden:
The first three digits are implemented;
the last two digits are set to '00'
e.g. 162 00.

Using a map location



Select from map

After selecting **Select from Map** from the Destination Entry menu, the map screen showing the current vehicle location is displayed.

- Scroll the map until the required location is under the cross-wire marker.

The location can be stored as a destination or as a way point, see **Confirm destination** on page 8-1.

6-16 Route setting

Using a motorway entrance/exit



1 Enter motorway name

After selecting **Motorway Entrance/Exit** from the Destination Entry menu, The alpha keyboard screen is displayed showing 'Input Motorway Name'.

- Enter the motorway name required and touch **List**, see **Text input** on page 2-8.

The list of possible motorways from the characters entered is displayed.

- Select the motorway required.

Note: To enter numbers in the motorway name, touch **Sym.** to select the special characters keyboard screen.

2 Select entrance/exit

Selecting the **Ent./Exit** button on the previous screen displays the screen shown above.

- Touch **Entrance** if you wish to join the motorway at this junction.
- Touch **Exit** if you wish to leave the motorway at this junction.

3 Select junction

The screen shows the list of junction entrances (or exits, if chosen on the previous screen) on the motorway.

- Select the entrance (or exit) required.

The destination details are displayed for confirmation of the address, see **Confirm destination** on page 8-1.

Using an intersection



1 Enter first street name

After selecting **Intersection** from the Destination Entry menu, the alpha keyboard screen is displayed showing 'Input First Street Name'.

- Enter the name required for the first street and touch **List**, see **Text input** on page 2-8.

The list of possible streets from the characters entered is displayed.

- Select the street required.

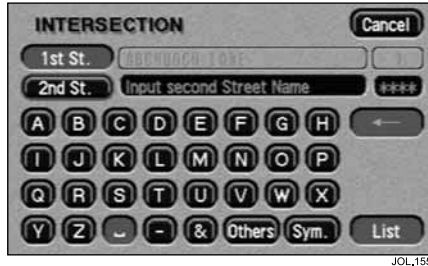

2 Enter second street name

The alpha keyboard screen is displayed showing the name of the first street and 'Input Second Street Name'.

- Enter the name required for the second street and touch **List**, see **Text input** on page 2-8.

The list of possible streets from the characters entered is displayed.

- Select the street required.

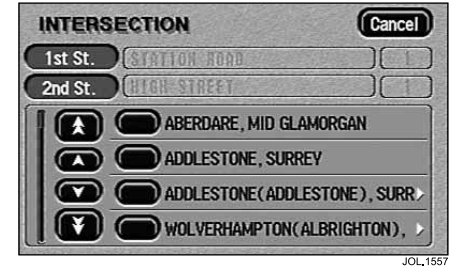

3 Select town

The screen shows the list of towns where the selected intersection occurs.

- Select the town required.

The destination details are displayed for confirmation of the address, see **Confirm destination** on page 8-1.

Working with stored locations

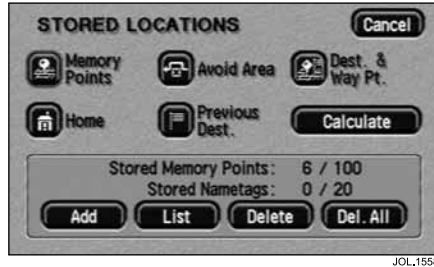

JOL1558

Stored locations menu

In the upper portion of the menu, the various types of stored location are shown:

Memory Points

Home

Avoid Area

Previous Dest.

Dest. & Way Pt.

- Select the type of stored location required.

In the lower portion of the screen, the current number of stored locations of the selected type/maximum number, is now displayed.



Stored location actions

The four touch buttons (Add, List, Delete, Del. All), operate in a similar manner for all types of stored location.

- Touch the action button required.

These actions are described in the following pages for each type of stored point.

Note: If an action is not available for the stored location you have chosen, its touch button will be shown shaded.

For example, if a home position has already been stored, another one cannot be added.



Calculate

If required, a new route calculation can be made.

7-2 Using stored locations

Memory points

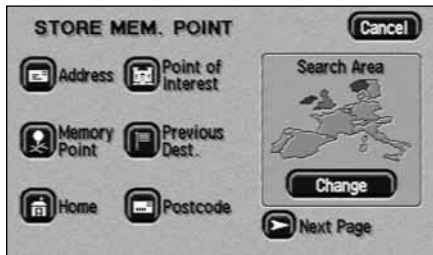

JOL11559

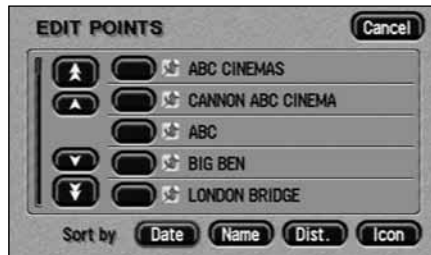

JOL11560



JOL11561

Add

After touching **Add**, the Store Memory Point menu is displayed.

- Select the menu item you wish to use.
- Enter or select the details required.

The new point is added to the list of stored memory points.

Note:

1. The Store Memory Point menu is used in the same way as the Destination Entry menu. For more information, see **Destination entry menu** on page 6-1.
2. To identify the new memory point, select it from the list, touch **Name**, and enter the name required. See **List** on this page.

1 List

After touching **List**, the list of stored memory points is displayed showing 'Edit Points' at the top of the screen.

- Select an entry to view its location details.

List sorting

- Touch **Date**, **Name**, **Dist.** or **Icon** to sort the list as required.

Note:

1. When sorted by Distance, the points are shown ordered by distance from the current location of the vehicle.
2. When sorting by Icon, the icons are listed in the order they appear on the icon selection screen (left to right, top row first). See **Icon list** on page 7-3.

2 Location details

The location details include Icon, Name, Position and Tel.

- Select the appropriate touch button to change or enter any of the location details. (For details of the icons available, see **Icon list** on page 7-3.)
- Touch the phone icon to call the phone number (if a Jaguar telephone is fitted).

Navigation nametags

This feature is part of the voice activation system (where fitted).

- Touch the **Add Nametag** or **Play Nametag** button as required. For more information, see the JaguarVoice Handbook.

Memory points (continued)

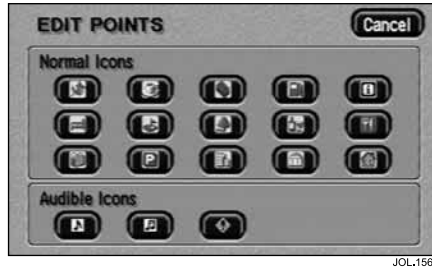

JOL_1562

3 Icon list

After touching **Icon**, the 15 normal icons, and three audible icons are displayed.

- To select, touch the icon required.

Normal icon

This is the icon displayed on the map to indicate the map location of the memory point. It replaces the default icon, used when the point is stored.

Audible icon

When an audible icon is selected, a distinctive chime will be heard when the vehicle is approaching the map location of the memory point.

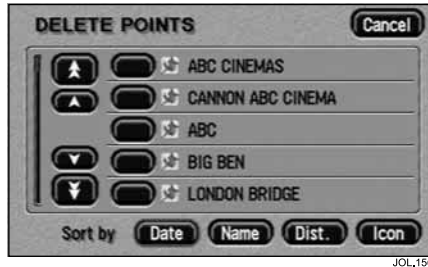

JOL_1563

Delete

After touching **Delete**, the list of memory points is displayed showing 'Delete Points' at the top of the screen.

- Select the entry to be deleted.

The screen shows the details of the selected point and 'Delete this Memory Point? Yes/No'.

- Touch **Yes** to confirm.

The screen briefly shows 'Memory Point Deleted'.

Del. all

After touching **Del. All**, the screen shows 'Delete all Memory Points? Yes/No'.

- Touch **Yes** to confirm.

The screen briefly shows 'All Memory Points Deleted'.

7-4 Using stored locations

Home



JOL1564



JOL1565



JOL1566

Add

After touching **Add**, the Set Home menu is displayed.

- Select the menu item you wish to use.
- Enter or select the details required.

The home position is stored.

Note: The Set Home menu is used in the same way as the Destination Entry menu. For more information, see **Destination entry menu** on page 6-1.

List

After touching **List**, the map screen is displayed, showing the location and address of the stored home position.

- Scroll the map to adjust the location if required.
- Touch **OK** to continue.

Delete

The screen shows the location of the current home position and 'Delete Home Position? Yes/No'.

- Touch **Yes** to confirm.

The screen briefly shows 'Home Deleted'.

Del. all

The **Del. All** touch button cannot be used with home position.

Avoid area

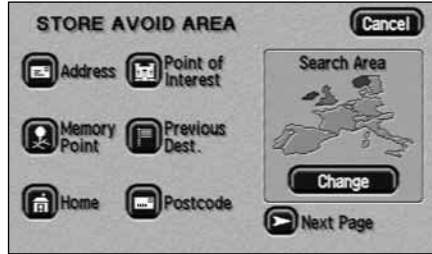

JOL_1567

Add

After touching **Add**, the Store Avoid Area menu is displayed.

- Select the menu item you wish to use.
- Enter or select the details required.

The new area is added to the list of stored avoid areas.

Note:

1. The Store Avoid Area menu is used in the same way as the Destination Entry menu. For more information, see **Destination entry menu** on page 6-1.
2. In some circumstances, to calculate a satisfactory route, it may not be possible to avoid all the selected areas.

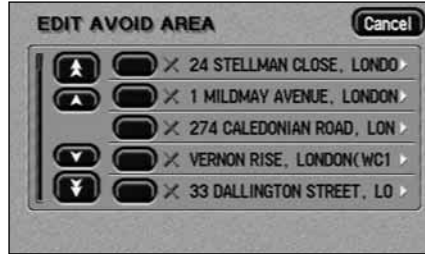

JOL_1568

List

After touching **List**, the list of stored avoid areas is displayed.

- Select the item required.

The map screen is displayed, showing the location and address of the selected area.

- To adjust the size of the area, touch the **Enlarge** or **Reduce** button.
- To adjust the position of the area, scroll the map as required.
- When finished, touch **OK**.

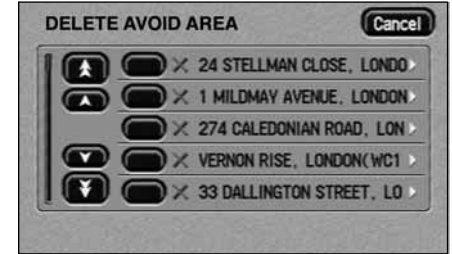

JOL_1569

Delete

After touching **Delete**, the list of avoid areas is displayed, showing 'Delete Avoid Area' at the top of the screen.

- Select the item to be deleted.

The screen shows 'Delete this Avoid Area? Yes/No'.

- Touch **Yes** to confirm.

The screen briefly shows 'Avoid Area Deleted'.

Del. all

After touching **Del. All**, the screen shows 'Delete all Avoid Areas? Yes/No'.

- Touch **Yes** to confirm.

The screen briefly shows 'All Avoid Areas Deleted'.

7-6 Using stored locations

Previous destination

Add

The **Add** touch button cannot be used with previous destinations. These are added automatically to the list of previous destinations when the destination is entered.

List

The **List** touch button cannot be used with previous destinations. These can only be viewed by using the **Delete** touch button.



Delete

After touching **Delete**, the list of previous destinations is displayed showing 'Delete Prev Dest' at the top of the screen.

- Select the entry to be deleted.

The screen shows 'Delete this Previous Destination? Yes/No'.

- Touch **Yes** to confirm.

The screen briefly shows 'Previous Destination Deleted'.

Del. all

After touching **Del. All**, the screen shows 'Delete all Previous Destinations? Yes/No'.

- Touch **Yes** to confirm.

The screen briefly shows 'All Previous Destinations Deleted'.

Destination and way point



2. The Store Dest. & Way Point menu is used after a destination or way point has been entered for the first time using the Destination Entry menu.



Add

After touching **Add**, the Store Dest. & WP menu is displayed.

- Select the menu item you wish to use.
- Enter or select the details required.

If a destination was entered, it will be stored as the current destination. If a way point was entered, it will be added to the list of way points.

Note:

1. The Store Dest. & Way Point menu is used in the same way as the Destination Entry menu. For more information, see **Destination entry menu** on page 6-1.

List

After touching **List**, the list showing the stored way points and destination (if entered) is displayed. The first way point to be visited is at the bottom of the list and the destination at the top.

- Select an entry to view its map location.
- On the map, the location details for the selected way point (or the destination), are displayed at the top of the screen.
- To adjust the position of the way point (or destination), scroll the map as required.
 - When finished, touch **OK**.

7-8 Using stored locations

Destination and way point (continued)

Way point order

If required, the order in which the way points are visited can be changed.

- Select the **Chg. Order** touch button.
- Touch the button against each way point in turn, to select the new order required, starting with the first way point to be visited.
- When finished, touch **OK**.
- To return to the previous screen, touch **Chg. Location**.

The **Undo** button can be pressed to clear the new selected order (made using the **Chg. Order** button) and allow the order to be reset.



Delete

After touching **Delete**, the list of way points and the destination (if entered) is displayed, showing 'Delete Dest. & WP' at the top of the screen.

- Select the entry to be deleted.

The screen shows 'Delete Destination? Yes/No', or 'Delete this Way Point? Yes/No'.

- Touch **Yes** to confirm.

The screen briefly shows 'Destination Deleted', or 'Way Point Deleted'.

Note: The **Delete** touch button does not delete the destination.

Del. all

After touching **Del. All**, the screen shows 'Delete all Way Points? Yes/No'.

- Touch **Yes** to confirm.

The screen briefly shows 'All Way Points Deleted'.

Note: The **Delete All** touch button does not delete the destination.

Route calculation

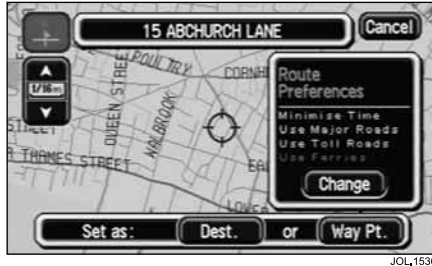

1 Confirm destination

After entering an address, or selecting a map location, the map screen is displayed showing its location. The address details are shown at the top of the screen. The address can be stored as a destination or as a way point.

- If required, scroll the map to adjust the location.
- To store as a destination touch **Dest.** (see **Calculating the route** on this page).
- To store as a way point touch **Way Pt.** (see **Storing way points** on page 8-3).

Route settings

- To change the route settings, touch **Change**. See **Route preferences** on page 5-4.

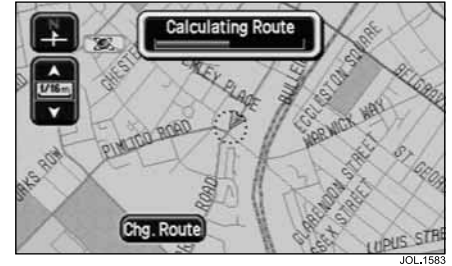

2 Calculating the route

After storing the destination (or final way point), the map screen shows 'Calculating Route' while the route is calculated.

- To change route settings, touch **Chg. Route**. See **Route preferences** on page 5-4.

8-2 Route calculation and guidance

Route calculation (continued)



JOL1531

Note: Only one route is calculated if the route has way points set, or if the route is over 1000 miles (1000 km) long.

3 Confirm route

Following calculation, the screen shows the whole route, with the total route distance, and estimated travelling time displayed at the top of the screen. Up to three possible routes are calculated. Where the route includes a ferry crossing, a ferry symbol is shown.

- To view an alternative route, touch **Next**.
- To change route settings, touch **Chg. Route**. see **Route preferences** on page 5-4.
- To accept a route, touch **Start** (or commence driving). See **Following guidance** on page 8-5.

Storing way points

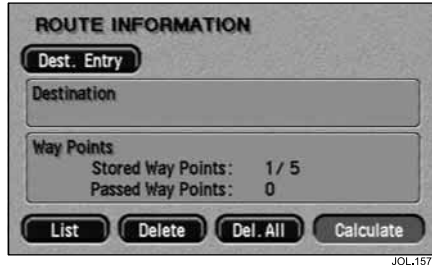

JOL_1574

1 First way point

After selecting **Way Pt.** for the first time from the Confirm Destination screen, the address entered is stored as the first way point, and the Route Information screen is displayed, as shown above. This screen also shows details of the destination (if entered).

- To enter another way point (or the destination), touch **Dest Entry**. The Destination Entry menu is displayed, see **Destination entry menu** on page 6-1.

Editing way points

For information on using the **List**, **Delete** and **Del. All** buttons, see **Destination and way point** on page 7-7.

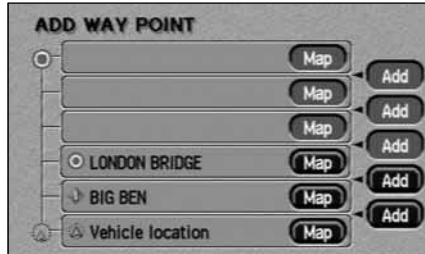

JOL_1575

2 Additional way points

After selecting **Way Pt.** again from the Confirm Destination screen, the Add Way Point screen is displayed. This screen lists the way points already entered, and the destination (if entered).

- Choose the position required in the list for the way point you are about to add, and touch the appropriate **Add** button.

The Route Information screen is displayed again, showing the number of way points entered. From this screen you can enter another way point, the destination, or start the route calculation.

Map location

- To view the map location of a way point or destination, touch the appropriate **Map** button.

8-4 Route calculation and guidance

Storing way points (continued)

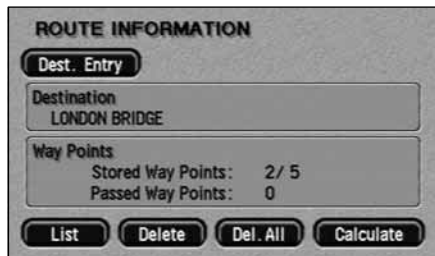

JOL1576

3 Calculate route

If the destination has been entered, then, after storing the final way point, the route calculation can be started from the Route Information screen. This screen should now show details of the destination, and the number of way points entered.

- To start the route calculation, touch **Calculate**. See **Calculating the route** on page 8-1.

Note: If the destination has not been entered at this stage, touch **Dest Entry**. When the destination has been entered, the route will be calculated after touching **Dest.** from the Confirm Destination screen. See **Confirm destination** on page 8-1.

Route guidance

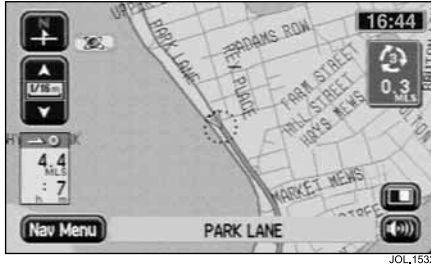

JOL_1532

Following guidance



WARNING:

Only operate, adjust or view the system when it is safe to do so.

After touching **Start**, the initial map screen while under guidance is displayed. The route is shown highlighted, with the current road name shown in the text area at the bottom of the screen.

Drive away, following the voice guidance given by the system. Continue to follow the voice guidance until the end of the route is reached.

The touch controls, types of guidance screen and other guidance features are described in the following pages.

Distance units

Distances are shown on the screen, and given in voice guidance, either in Imperial units (miles) or in Metric units (kilometres and metres). For information on changing the unit selection, see the Driver's Handbook, section 1.

Time/distance to destination

While driving under guidance, the estimated time (if selected) and distance remaining to the end of the route are shown on the screen.

While far-out – Before the vehicle reaches the start of the highlighted route, and during route recalculation, the straighten distance and direction to the destination are shown.

Message centre guidance (where fitted)

Route guidance information can be displayed on the instrument panel message centre. The display of this information on the message centre can be selected or deselected as required, see **Guidance options** on page 5-10.

Breaks in journey

While driving under guidance, the journey can be broken without affecting the stored route. When the journey is continued, the route guidance will resume automatically.

Whole route display

The map screen showing the entire route can be displayed. This is selected from the Route Options menu, see **Display route** on page 5-5. From this screen the display of the last portion of the route and the route turn list can be selected.

Avoiding points and areas

At any time while a route is set, you can select a point to be avoided on the current route. This can be enlarged into an avoid area if required. When the route is recalculated, the points or areas selected will be avoided (where possible). see **Turn list** on page 5-5

Avoid areas can also be set up to be avoided permanently in all route calculations. see **Avoid area** on page 7-5.

8-6 Route calculation and guidance

Route guidance (continued)

Touch controls

The touch controls displayed on the guidance map screen are as follows:



Nav Menu button

Displays the Navigation menu, see **Navigation menu** on page 5-3.



Audible repeat button

Repeats the last audible instruction. If the manoeuvre point has been passed, the audible instruction for the next manoeuvre point will be heard.



End call button

Ends a phone call. Displayed in place of the **Repeat** button, while a phone conversation is in progress. (If a Jaguar telephone is fitted.)



Guidance screen button

Displays the guidance screen overlay in place of the next turn arrow icon. See **Screen types** on page 8-9.



Turn arrow button

Displays the next turn arrow icon in place of the guidance screen overlay. See **Screen types** on page 8-9.



Map orientation buttons

These buttons select the desired map orientation (north or vehicle heading to the top of the screen). The current selection is shown on the map.

Note: Above the 2 miles (4 kilometres) zoom level, only north orientation is available.



Zoom control

Selects the desired map zoom level by touching one of the arrow symbols. The currently selected scale is shown. See **Zoom control operation** on page 5-2.

Route guidance (continued)

Additional touch buttons

These buttons are displayed after touching the map display.



Chg. Route button

Selects the Route Options menu, to make changes to the route preference settings. See **Route preferences** on page 5-4.



Ent. Dest. button

Stores a selected map location as a destination. (Displayed in place of the **Chg. Route** button, after touching the screen twice within five seconds.)



Store button

Stores a selected map location as a memory point.



POI button

Selects the quick points of interest function to display POI icons on the map. For more information, see **Quick points of interest (POI)** on page 5-11.



Home button

Sets a route to the home position. (Only displayed when a home position is set.)

Note: If the **Ent. Dest.** button or the **Home** button is touched, the current route will be cancelled and a new route calculated.

8-8 Route calculation and guidance

Route guidance (continued)

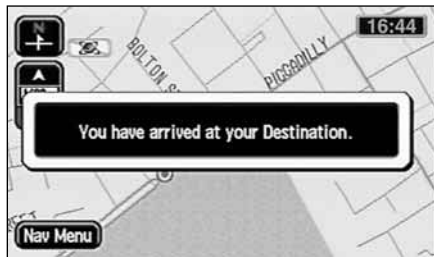

JOL1533

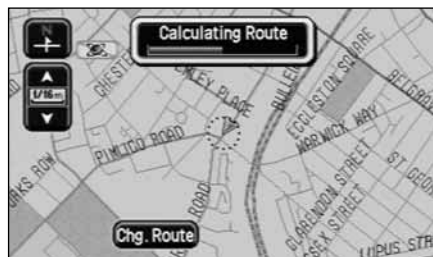

JOL1583

Arrival guidance

When the vehicle arrives at the destination, the screen shows the destination location details. This is confirmed by voice guidance. The system is now ready for further use.

Auto reroute

While under guidance, if the vehicle deviates from the route, a new route will be calculated automatically. While the route is being recalculated the screen shows 'Calculating Route' and the time and distance to destination information is replaced by the straight-line distance and direction to the destination.

Note: If the vehicle is within ¼ mile (400 metres) of the destination or next way point, the route recalculation will not occur.



JOL1584

Way points

When the vehicle arrives at a way point, the screen shows 'You have arrived at your Way Point'. When the journey is resumed, route guidance continues automatically, either to the next way point or to the final destination.

After way points have been visited (or the route cancelled), they will be deleted from the way points list.

Note: As way points are entered, they are automatically added to the list of previous destinations.

Screen types



Full Screen

When set to Full Screen, the screen normally shows the map display, with the next turn icon in the top right-hand corner. Before each manoeuvre point, the guidance screen overlay is displayed automatically. (The overlay can also be displayed manually by touching the Guidance Screen button.)

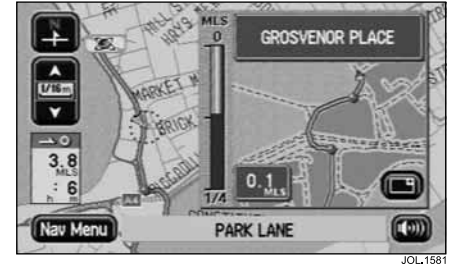

Map screen

Two map screen options are available: Split Screen and Full Screen.

- To select an option, choose **Display Options** from the Navigation menu.

Split Screen

When set to Split Screen, the map display always shows the guidance screen overlay while a route is set.

Guidance screen (turn arrows)

The guidance screen overlay is always displayed while the Split Screen option is selected, and is also displayed when selected manually while the Full Screen option selected.

Two guidance screen options are available: Turn Arrows and Turn List.

- To select an option, choose **Display Options** from the Navigation menu.

When set to Turn Arrows, before each manoeuvre point, the guidance screen overlay shows the next junction diagram.

8-10 Route calculation and guidance

Screen types (continued)

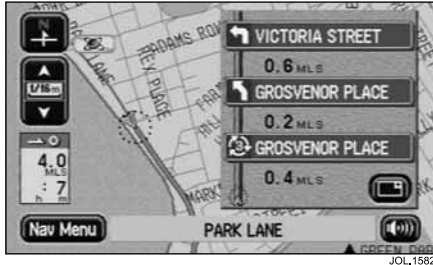

Guidance screen (turn list)

When set to Turn List, the guidance screen overlay shows the current portion of the route turn list. Before each manoeuvre point, the next junction diagram is displayed.

About this handbook	1-2	Getting started	
– in-car telephone features	1-2	– initial map display	1-8
Control panel	1-6	– road safety caution	1-7
Destination entry menu	6-1	– touch controls	1-8
– address	6-3	– zoom control operation	1-9
– change search area	6-2	How the system works	1-1
– home	6-7	– clock adjustment	1-1
– intersection	6-17	Initial map display	5-1
– memory point	6-6	– touch controls	5-1
– motorway entrance/exit	6-16	– zoom control operation	5-2
– point of interest	6-8	Loading the map DVD	1-6
– postcode	6-14	Main features of the system	4-1
– previous destination	6-13	– avoid areas	4-1
– select from map	6-15	– points of interest	4-1
Display options	5-10	– screen guidance	4-1
– 2D/3D View	5-10	– stored locations	4-1
– guidance options	5-10	– voice guidance	4-1
– map options	5-10	– way points	4-1
Example – Route setting	3-1	Menu structure	4-3
Frequently used functions	4-2		

Index

- Navigation menu 5-3
 - audible instructions 5-3
 - functions available on the move 5-3
- Navigation set up menu 5-7
 - average speed settings 5-7
 - calibration 5-9
 - map version 5-8
 - quick POI selection 5-7
 - restore system defaults 5-8
- On-screen control buttons 2-6
 - volume adjustment 2-7
- Perspective views 5-14
 - 3D map angle 5-15
 - initial map display 5-14
 - map dimension 5-15
 - map display under guidance 5-14
 - scrolling the map 5-14
 - selecting 2D/3D views 5-15
- POI category list 4-4
- Quick points of interest 5-11
 - cancelling POI icon display 5-12
 - changing the categories 5-12
 - POI icon display 5-11
 - POI information 5-12
 - selecting a category 5-11
- Route calculation 8-1
 - calculating the route 8-1
 - confirm destination 8-1
 - confirm route 8-2
- Route guidance 8-5
 - arrival guidance 8-8
 - auto reroute 8-8
 - avoiding points 8-5
 - breaks in journey 8-5
 - distance units 8-5
 - message centre guidance 8-5
 - time/distance to destination 8-5
 - touch controls 8-6
 - way points 8-8
 - whole route display 8-5
- Route options menu 5-4
 - calculate 5-6
 - cancel guidance 5-6
 - delete next way point 5-6
 - detour 5-4
 - display whole route 5-5
 - route preferences 5-4

Safety information	1-3	Using a point of interest (POI)	6-8
Screen displays	2-1	– categories/sub-categories	6-11
– initial map display	2-1	– entry by category	6-9
– menus	2-3	– entry by POI name	6-8
– name lists	2-3	– entry by town	6-8
– scrolling the map	2-2	– other selection methods	6-10
Screen types	8-9	– POI list	6-11
– guidance screen	8-9	Using the system	1-2
– map screen	8-9	– alternative routes	1-5
Stored locations menu	7-1	– errors in vehicle position	1-4
– avoid area	7-5	– Jaguar Dealership locations	1-5
– destination and way point	7-7	– languages and distance units	1-5
– home	7-4	– map DVDs	1-5
– memory points	7-2	– reception of GPS signals	1-4
– previous destination	7-6	– road junction layouts	1-5
Storing way points	8-3	– route guidance precision	1-4
– additional way points	8-3	– screen cleaning	1-5
– calculate route	8-4	– time and distance to destination	1-3
– first way point	8-3	– town name lists	1-5
Text input	2-8		
– character input	2-8		
– number input	2-8		

JJM 10 05 24/22