

Climate Control

INTRODUCTION

This vehicle is fitted with one of the following climate control systems:

- Automatic climate control system with an LCD (Liquid Crystal Display) screen. See '*Automatic Climate Control*', page 152.
- Automatic climate control system with touch-screen (shared with the navigation and audio systems). See '*Touch-screen Climate Control*', page 156.

General information applicable to both systems is given below.

RECOMMENDED OPERATION

Use of air conditioning

The climate control system is fitted with air conditioning to provide cooling and dehumidified air.

The dry airflow is also effective in preventing misting of the windows. It is recommended that air conditioning is used in all climatic conditions throughout the year, even when warm airflow is required.

Close all windows and the sunroof when the air conditioning is on to ensure satisfactory operation.

Note: *Selecting air recirculation will improve the performance of the air conditioning in very hot conditions.*

Use of air recirculation

The air conditioner/heater system is supplied with fresh air via an intake flap.

The flap may be closed to allow the air inside the vehicle to be recirculated. This helps to prevent unpleasant odours from being drawn into the vehicle.

Air recirculation may be manually selected either for an automatically timed period or to remain on continuously (latched recirculation).

When latched recirculation is selected, the air conditioning will switch on automatically to reduce condensation.

Note: *When air recirculation is selected, the sound of the airflow will change. This is normal.*

The air conditioning, recirculation and other functions are fully controlled in AUTO mode to provide optimum comfort under most driving conditions.

It is recommended that AUTO is selected as the normal operating mode.



WARNING:

To prevent humidity build up inside the vehicle and possible screen misting, avoid driving with the air conditioning system off or in manual air recirculation for prolonged periods.

GENERAL POINTS

To ensure the satisfactory operation of the climate control system, note the following points:

- Ensure that the external grille at the base of the windscreen, which provides fresh air for the climate control system, is kept clear of leaves, snow or obstructions.
- Air ducts under the front seats supply the rear passenger footwells (refer to illustration in '*AIR DISTRIBUTION*', page 151). Objects or material placed under the seats may block or obstruct the open ducts.

Climate Control

- The external air intake to the air conditioner/heater system is fitted with a filter. Ensure that the filter is changed at the specified service intervals to maintain efficient operation.
- If the air conditioning system is not used frequently, it should be run briefly at least once each week, with a cold setting, to prevent the seals from drying out with subsequent refrigerant leaks.
- Moisture removed from the air by the air conditioning unit is discharged onto the road underneath the vehicle. After stopping, puddles of water may form underneath the vehicle: this is normal.

AUXILIARY HEATER (DIESEL ONLY)

The auxiliary heater aids in warming the engine and interior compartment. It is integrated into the cooling system and is automatically switched on or off depending on the coolant temperature and outside air temperature, while the engine is running.

There are two types of auxiliary heater, either fuel-fired or electric. Vehicles are only fitted with fuel fired heaters in certain cold climate countries.

It is possible that when the fuel-fired heater is activated, exhaust gas may appear from under the side of the vehicle for a short time. This is normal.

PANEL ILLUMINATION

With the exterior lighting switched on, the graphics on the panel controls are illuminated by low level backlighting.

The illumination level is adjusted by the common instrument pack dimmer control.

Climate Control

AIR DISTRIBUTION

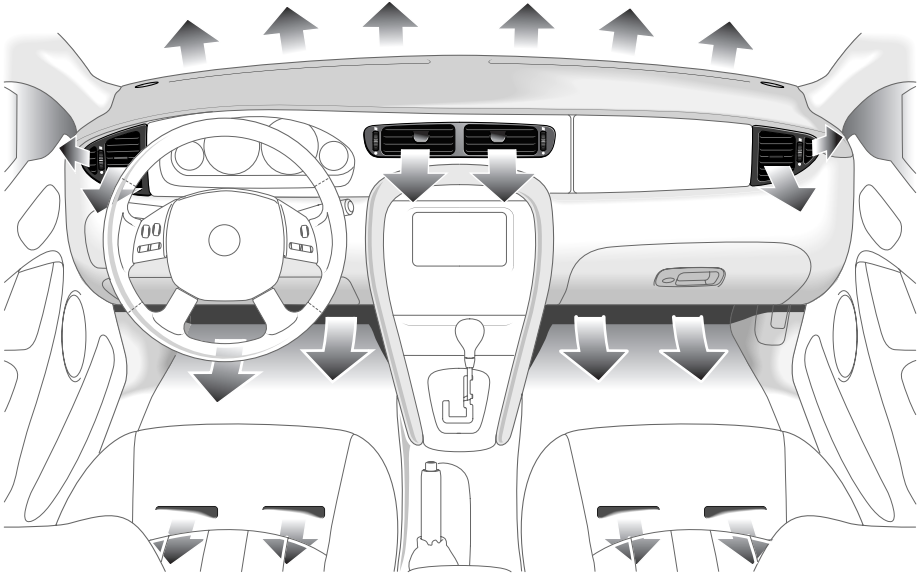

JAG0785

The illustration shows the location of the air vents within the vehicle.

The appropriate air distribution is selected automatically when operating in AUTO mode.

On both climate control systems, the distribution of air between the screen, facia and floor level can be manually selected using the panel controls.

The airflow from the facia face level vents is regulated using thumbwheel controls and adjustable direction vanes.

Automatic Climate Control

AUTOMATIC CONTROL PANEL

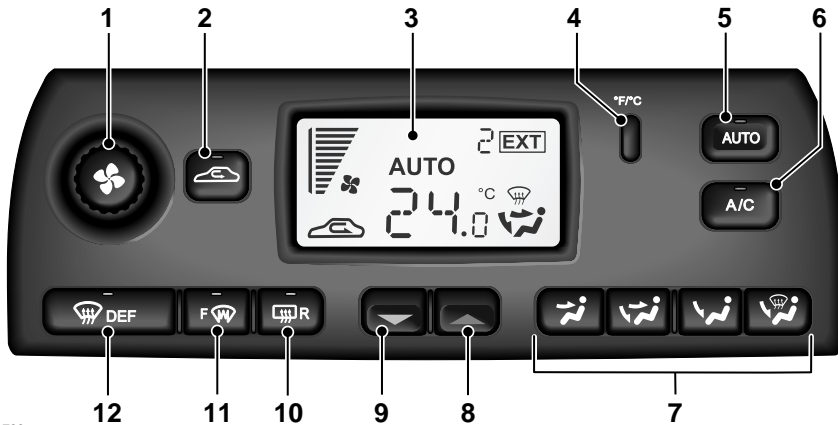

JAG0788

1. Blower speed and system on/off.
2. Recirculation/fresh air.
3. Display panel with typical symbols.
4. Celsius/Fahrenheit selector.
5. Automatic operation.
6. Air conditioner on/off.
7. Air distribution.
8. Increase temperature.
9. Decrease temperature.
10. Heated rear screen/door mirrors.
11. Heated front screen (where fitted).
12. Defrost.

The automatic climate control system maintains the interior of the vehicle at the temperature selected by the occupant. The heat input, air conditioning, blower speed, air intake and distribution are adjusted automatically to maintain the desired temperature.

Note: It is advisable to allow the system to stabilise before making large changes to the temperature setting, particularly at the start of a journey (see 'TEMPERATURE SELECTION', page 153).

Automatic control (AUTO) may be overridden at any time. Defrost/demist operation is available and also manual selection of blower speed, air distribution, recirculation, air conditioning and windscreen heating.

The climate control functions are selected by push buttons and a rotary control. When a button is pressed, selection is confirmed by a beep and illumination of the button LED.

Most functions also have associated graphic symbols displayed on the LCD (Liquid Crystal Display) screen.

Automatic Climate Control

TO SWITCH THE SYSTEM ON

The climate control system operates in position **II** (run) of the starter switch.

With the starter key turned to the run position, the system will switch on in the operating mode last set.

For normal usage select AUTO mode.

AUTO MODE

 Automatic operation provides a controlled environment over a temperature range of 17°C (61°F) to 31°C (89°F) and should be regarded as the normal operating mode.



To select automatic climate control press the AUTO button; the word AUTO appears on the LCD screen to confirm selection.

Select the required temperature.

Front and rear screen heating and timed air recirculation may be selected in AUTO mode. Selecting any other control will cancel AUTO operation.

Automatic operation cannot be deselected using the AUTO button. To exit AUTO mode, select another mode or press the blower control knob to switch the system off.

TEMPERATURE SELECTION

  Set the required interior temperature with the red and blue arrowed buttons. Press the red button to increase temperature and the blue button to decrease temperature.

The selected temperature will appear on the lower part of the LCD screen.

Pressing the buttons to select the maximum or minimum temperature settings causes the display to change to HI or LO respectively and cancel AUTO mode.

To quickly jump from HI or LO to a convenient midrange temperature of 23°C (73°F), press and hold AUTO for a few seconds.

When AUTO is selected, the system constantly monitors the conditions inside and outside the vehicle. For your maximum comfort, it is advisable to allow the system to stabilise before making large changes to the temperature setting, particularly at the start of a journey.

EXTERNAL TEMPERATURE

The external (EXT) temperature is displayed at the top of the screen.

CELSIUS/FAHRENHEIT SELECTION

 Press the button to change the scale between degrees Celsius (°C) and degrees Fahrenheit (°F) for the displayed internal and external (EXT) temperatures.

AIR RECIRCULATION

Timed air recirculation

 Press the button briefly to select timed air recirculation.

The fresh air intake is opened and the button LED extinguished at the end of the time-out period.

Automatic Climate Control

Latched air recirculation



Press and hold the button for a few seconds to select latched air recirculation. Selection is indicated by the screen symbol and two beeps.

Selecting latched air recirculation cancels AUTO operation.

To deselect latched air recirculation, press the recirculation button again, or select AUTO.



WARNING:

Prolonged operation with recirculation selected in cold, damp conditions could result in screen misting.

WINDSCREEN DEFROST/DEMIST

Frost and heavy misting



To remove frost or heavy misting from the windscreen, press the DEF button.

- The blower switches on automatically at 70% of maximum speed, but the speed can be increased or reduced manually if required.
- Air conditioning switches on automatically (to dehumidify the air) and cannot be deselected.
- Recirculation is cancelled and cannot be selected.
- The front screen heater and the rear screen heater/door mirror heaters switch on automatically, provided the engine is running.

To deselect defrost mode, press AUTO (recommended operating mode, to maintain a mist-free screen).

Light misting



To prevent or remove light windscreen misting, select manual air distribution to windscreen and feet. See 'MANUAL AIR DISTRIBUTION', page 155.

Note: Air conditioning will reduce misting, even when warm airflow is selected: the system will still dehumidify the air.

HEATED SCREENS AND DOOR MIRRORS



The front (F) and rear (R) screen heaters may be switched on and off in any mode, including system off, but will only operate when the engine is running. The door mirror heaters are also controlled by the rear screen heater button.

The front screen heater switches off automatically after three minutes. The rear screen and door mirror heaters switch off automatically after six minutes. The windscreen heaters may be manually deselected during the time-out period using the push buttons.

In cold ambient conditions, at the start of a journey, the front and rear screen heaters will switch on automatically for the time-out period.

Automatic Climate Control

AIR CONDITIONING



Press to switch the air conditioning on or off.

The air conditioning system is controlled automatically in AUTO mode to maintain the desired temperature and humidity (even if higher temperature settings are selected). Deselecting A/C cancels AUTO mode.

The air conditioning system is also switched on automatically in defrost mode (DEF) in order to dehumidify the air; it cannot be deselected in this mode.

BLOWER SPEED



Set the blower speed as required with the rotary control knob. Blower speed is shown as a series of bars on the LCD screen.

When operating in AUTO mode, blower speed is controlled automatically (but not displayed) and any adjustment of the knob will cancel AUTO mode.

Note: In AUTO mode, the blower only operates at low speed, if heating is required, until the engine is warm.

MANUAL AIR DISTRIBUTION

Air distribution is automatically controlled in AUTO and defrost modes.

Press one of the four air distribution buttons to cancel the current mode and select manual operation. The symbol for the selected air distribution will appear on the LCD screen.

The air distribution options are:



Airflow directed at face level only; optimum position for cooling interior (if cool airflow selected).



Airflow distributed to the face and feet.



Airflow directed to foot level; optimum position for heating interior (if warm airflow selected).



Airflow distributed to the windscreen and feet; select to prevent or remove light misting and when heating the interior.

TO SWITCH THE SYSTEM OFF

Press in the blower rotary control knob to switch the climate control system off.

If the blower control knob is pressed again, the system will switch on in the previous mode set.

RAM AIR

With the climate control system switched off, air recirculation is automatically selected (intake flap closed). To select fresh air with the system off, press one of the air distribution buttons.

With the blower switched off, the fresh airflow results from the forward motion of the vehicle (ram air effect).



WARNING:

Selecting ram air (or switching the system off when the windows are closed) may increase the possibility of screen misting due to reduced airflow.

Touch-screen Climate Control

INFORMATION

A general introduction to the touch-screen is given in 'TOUCH-SCREEN DISPLAY', page 229. The operating information given here refers to touch-screen climate control only.

The vehicle has both driver and passenger (dual zone) red and blue temperature control arrow buttons.

Controls and displays

The climate control system has its own menu on the touch-screen. A number of other buttons are also used for climate control and are located around the perimeter of the touch-screen. When a perimeter button is pressed, selection of the function is confirmed by a beep and, on most buttons, illumination of a Light Emitting Diode (LED).

An LCD screen below the touch-screen shows the interior temperatures set by the driver and passenger and the external (EXT) ambient temperature.

Note: *Using other systems and touch-screen displays, such as audio or navigation, does not affect the climate control settings.*

Panel illumination

With the exterior lighting switched on, the graphics on the panel controls are illuminated by low level backlighting.

The illumination level is adjusted by the common instrument pack dimmer control.

Touch-screen Climate Control

CONTROLS

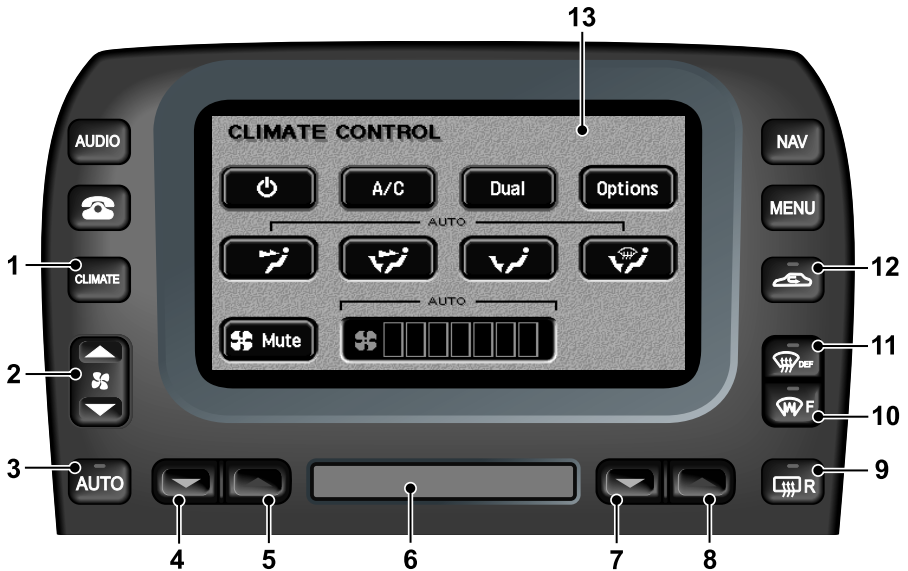

JAG0646

1. Select climate control touch-screen.
2. Adjust blower speed.
3. Select automatic operation.
4. Decrease left-hand zone temperature.
5. Increase left-hand zone temperature.
6. LCD screen: interior and exterior temperatures.
7. Decrease right-hand zone temperature.
8. Increase right-hand zone temperature.
9. Heated rear screen/door mirrors.
10. Heated front screen.
11. Defrost operation.
12. Select air recirculation.
13. Touch-screen.

Touch-screen Climate Control

Starter Switch ON

The climate control system operates in position **II** of the starter switch.

When the starter switch is turned to position **II** or the engine is started, the Jaguar logo will be displayed briefly followed by the last touch-screen selected (e.g. radio).

The climate control system will be set to the climate operating mode selected previously.

CLIMATE CONTROLS DISPLAY

There are two climate control touch-screen displays, one for the system 'ON' state and the other for system 'OFF'/ram air mode. Smaller pop-up displays appear briefly when selecting air recirculation or adjusting the blower speed.

Most climate functions can be selected using the perimeter buttons without displaying the climate touch-screen buttons.

 To select the touch-screen display, press the **CLIMATE** button.

To exit the climate control screen, select another system function, e.g. **AUDIO**.

AUTO MODE



Automatic operation provides a controlled environment over a temperature range of 17°C (61°F) to 31°C (89°F) and should be regarded as the normal operating mode.

 To select automatic climate control press the **AUTO** button and select the required temperature.

The **AUTO** mode touch-screen is shown above. If the touch-screen is not displayed, press the **CLIMATE** button.

Front and rear screen heating and timed air recirculation may be selected while remaining in **AUTO** mode. Selecting any other climate control perimeter button or touch-screen button will cancel **AUTO** operation.

Automatic operation cannot be deselected using the **AUTO** button. To exit **AUTO** mode, select another climate mode or touch the system **ON/OFF** button to switch the system off.

Touch-screen Climate Control

TEMPERATURE SELECTION



Set the required interior temperature with the red or blue arrowed buttons.

Press the red buttons to increase temperature and the blue buttons to decrease temperature.



The selected temperatures will appear on the LCD screen below the touch-screen.

Pressing the driver's buttons to select the maximum or minimum temperature settings causes the LCD screen to change to HI or LO respectively and cancels AUTO mode.

To quickly jump from HI or LO to a convenient mid-range temperature of 23°C (73°F), press and hold **AUTO** for a few seconds.

DUAL TEMPERATURE ZONES



With the **Dual** button illuminated, the system provides separate

temperature control of the driver and passenger zones.

Touch **Dual** to deselect dual temperature control; the passenger temperature will change to that of the driver's side. Using the driver's side temperature control buttons will now change both zone temperatures together.

To select dual temperature control, either touch **Dual** or press one of the passenger's side temperature control buttons.

EXTERNAL TEMPERATURE



The external (EXT) temperature is displayed on the LCD screen.

CELSIUS/FAHRENHEIT SELECTION



Touch the button to change the scale between degrees Celsius (°C) and degrees

Fahrenheit (°F) for the displayed interior and external temperatures.

Touch-screen Climate Control

TIMED AIR RECIRCULATION



JOL2066

 Press the button briefly to select air recirculation for a timed period only; the pop-up shown above will appear for a few seconds on top of the currently selected touch-screen.

The fresh air intake is opened and the button LED extinguished at the end of the timed period.

Latched fresh air

Pressing the air recirculation button when the button LED is illuminated will cancel recirculation and allow fresh air into the vehicle.

Deselecting air recirculation cancels AUTO mode.

LATCHED AIR RECIRCULATION



JOL2067

 To latch air recirculation (so that it remains selected), press and hold the air recirculation button until the pop-up changes from the timed to the latched recirculation symbol.

Selection is also indicated by two beeps and the button LED flashing four times then remaining illuminated.

Selecting latched recirculation cancels AUTO mode.

Caution: Prolonged operation with recirculation selected in cold, damp conditions could result in interior condensation.

Touch-screen Climate Control

WINDSCREEN DEFROST/DEMIST

Frost and heavy misting



To remove frost or heavy misting from the windscreen, press the **DEF** button.

- The blower switches on automatically at a high speed but the speed can be increased or decreased manually if required.
- Air conditioning switches on automatically and cannot be deselected.
- Recirculation is cancelled and cannot be selected.
- The front screen heater and the rear screen heater/door mirror heaters switch on automatically, provided the engine is running.

To deselect defrost mode, press **DEF** again, or press **AUTO** (recommended operating mode).

Light misting



To prevent or remove light windscreen misting, select manual air distribution to windscreen and feet (see '*MANUAL AIR DISTRIBUTION*', page 162).

HEATED SCREENS AND DOOR MIRRORS



The front screen heater (F) and the rear screen heater (R) may be switched on and off in any mode, including system off, but only operate when the engine is running. The door mirror heaters are also controlled by the rear screen heater button.



The front screen heater (where fitted) switches off automatically after four minutes. The rear screen and door mirror heaters switch off automatically after ten minutes.

The windscreen heaters may be manually deselected during the time-out period using the buttons.

In cold ambient conditions, at the start of a journey, the front and rear screen heaters will switch on automatically for the timed period.

Where a front screen heater is not fitted, the windscreen has a wiper park zone heater which operates automatically with no manual control.

Note: *The top three lines of the rear screen pattern are a concealed antenna and do not defrost the rear screen.*

Touch-screen Climate Control

AIR CONDITIONING



Touch the **A/C** button to switch the air conditioning on or off.

The air conditioning system is controlled automatically in **AUTO** mode. Deselecting A/C cancels **AUTO** mode.

The air conditioning system is also switched on automatically in defrost mode (DEF) but cannot be deselected.

BLOWER SPEED



Set the blower speed as required using the rocker button. Blower speed is shown as a series of bars on the touch-screen.

If the blower speed is changed while a non-climate control touch-screen is displayed, a pop-up display showing the blower speed bars will appear for a short period.

When operating in **AUTO** mode, blower speed is controlled automatically (but not displayed) and any adjustment of the button will cancel **AUTO** mode.

Note: In **AUTO** mode, the blower will only operate at low speed until the engine is warm, if heating is required in the vehicle.

BLOWER MUTE



To reduce the interior noise level, the blower speed may be quickly reduced to a preset level by touching the **Mute** button.

Selecting **Mute** will cancel **AUTO** mode, but touching the Mute button again will return operation to the previous state.

When JaguarVoice is fitted, the climate control system will automatically prevent any increase in blower speed while speech commands are given.

Note: The **Mute** function should only be used for short periods, as it reduces the efficiency of the climate control system.

MANUAL AIR DISTRIBUTION

Air distribution is automatically controlled in **AUTO** and defrost modes.

Touch one of the four air distribution buttons on the screen to cancel the current mode and select manual operation.

The air distribution options are:



Airflow directed at face level only; select to cool the interior.



Airflow distributed to the face and feet.



Airflow directed to feet level; select to heat the interior.



Airflow distributed to the windscreen and feet; select to prevent or remove light misting and when heating the interior.

Touch-screen Climate Control

SWITCHING CLIMATE CONTROL OFF

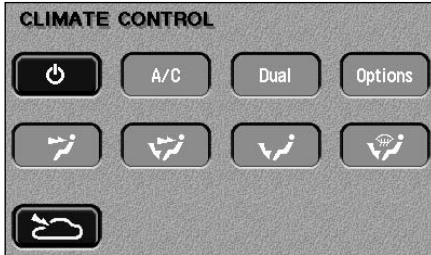

JOL2068



To switch the system off, touch the system on/off button on the climate control screen. The touch-screen will change to the system off/ram air climate control screen above.

Pressing the system on/off button again will return the system to the previous state.

It is recommended that **AUTO** is selected to switch the system on again.

RAM AIR

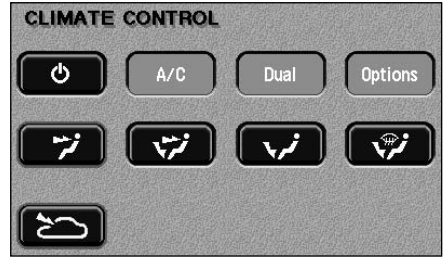

JOL2069

With the climate control system switched off, air recirculation is automatically selected (intake flap closed).

To select fresh air with the system off, touch the ram air button (bottom left on illustration). The intake flap will open with air distribution to face level automatically selected.

Any of the other air distribution modes may be selected manually using the touch-screen.

With the blower switched off, the fresh airflow results from the forward motion of the vehicle (ram air mode).

Touch-screen Climate Control

CLIMATE OPTIONS

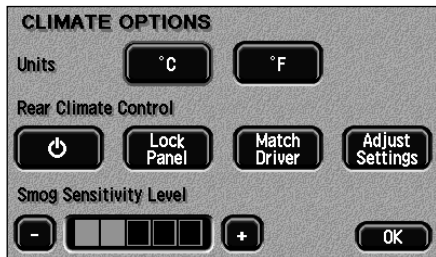

JOL2038

Options The Options button is displayed in place of the °C/°F button if the optional smog sensor and/or rear climate control panel (4-zone system) are fitted.

Touching Options displays the Celsius (°C) and Fahrenheit (°F) selection buttons. The display also shows either the rear control panel buttons or the smog sensor setting or both.

SMOG SENSING

Where fitted, the smog sensor detects road traffic pollutants and automatically selects air recirculation when the level of pollution outside the vehicle reaches a certain level. The level of pollution at which the smog sensor will respond can be adjusted on the Options screen.

Once the level of pollutants decreases, air recirculation will switch off (subject to the normal operation of the automatic climate control system).

To adjust smog sensitivity: Touch the + button to increase sensitivity to low smog levels. Touch the – button to decrease sensitivity.

Caution: Don't set the smog sensor to a needlessly high level in cold and damp conditions: this could result in interior condensation.