

Quick Overview

LOCKING AND UNLOCKING

Note: *Dependent upon vehicle configuration, the operation of the remote handset may differ from the following.*

Remote handset



JOL4689



Press to release door key



Press once to lock the vehicle and arm the alarm.

Press twice within 3 seconds to double lock the vehicle.

Press and hold to close the sunroof and any open windows (**Global closing**).



Press once to disarm the alarm, unlock the driver's door and unlock the luggage compartment.

Press again to unlock remaining doors.

Press and hold to open the sunroof and windows (**Global opening**).



Press once to switch the headlamps on for 25 seconds.



Press to unlock and open luggage compartment.

Unlocking mode alternatives

Single stage unlocking will unlock the vehicle with a single press. Two stage unlocking will unlock the driver's door and luggage compartment with a single press and all other doors with a second press.

To change between modes, press and hold the lock and unlock buttons on the remote handset simultaneously for four seconds. The direction indicators will flash twice to confirm the change.

Unlocking with the door key

If the vehicle is unlocked manually via the door lock, the key must be inserted in the starter switch within 15 seconds to prevent the alarm being activated.

Quick Overview

CENTRAL DOOR LOCKING

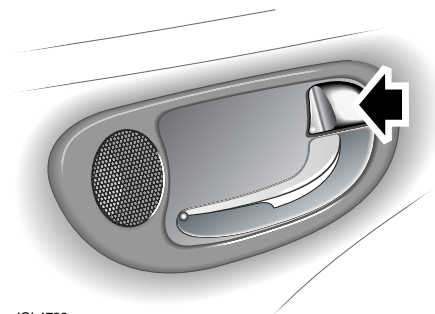

JOL4732

To lock all the doors, press the lock lever on either of the front doors.

To unlock all doors, pull the lock lever on either of the front doors.

Drive away door locking

The doors and luggage compartment will automatically lock when the vehicle's forward speed exceeds 7 km/h (5 mph).

This feature can be disabled by your Dealer/Authorised Repairer.

LUGGAGE COMPARTMENT

The luggage compartment is electrically locked and unlocked in conjunction with the driver's door.



To open the luggage compartment with the vehicle locked, press the luggage compartment button on the remote handset.

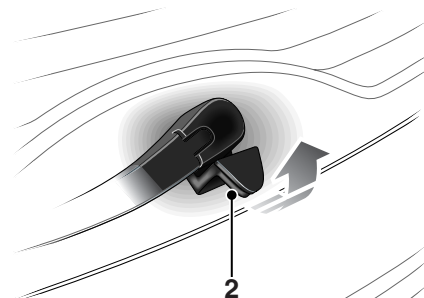
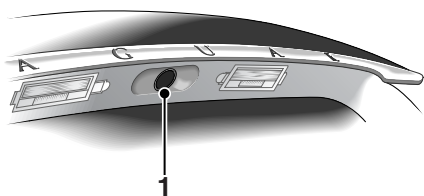

JOL4733

To open the luggage compartment with the vehicle unlocked, Press the release button **1** on the luggage compartment lid/tailgate.

Tailgate glass - Estate

To open the tailgate glass, press the release button **2**, located on the reverse of the tailgate handle and lift the glass.

Care Point

- The release button on the luggage compartment lid/tailgate is disabled when the vehicle is alarmed.

Quick Overview

CLOCK AJUSTMENT

Touch-screen



JOL4692

1. Press the **MENU** button on the touch screen surround to access the **MENU** screen.
2. Touch **System setup** to access the **System setup** screen.
3. Touch the **Set clock** icon.
4. Adjust the time by touching the hour and minute up or down arrow icons.
5. Touch the **12/24** icon to select between twelve or twenty-four hour display.
6. Touch **Set** to confirm.

Non-touch-screen

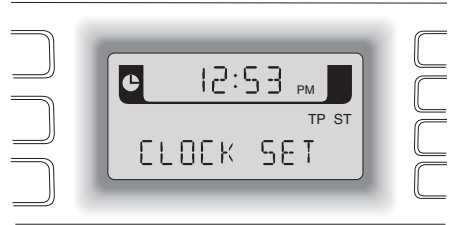

JOL4693

1. Press and hold the Audio **MODE** button until **TA VOLUME** is displayed.
2. Repeatedly press and release the **MODE** button until **CLOCK SET** is displayed.
3. Press the seek up/down keys to select either 12 or 24 hour format and press the **MODE** button to continue.
4. If 12 hour is selected, use the # key to denote **AM** or **PM**.
5. Enter the time in four-digit format using the key pad.
6. To exit, press and hold the **MODE** button until the display reverts to audio mode.

Quick Overview

SEATS

Manual seat adjustment

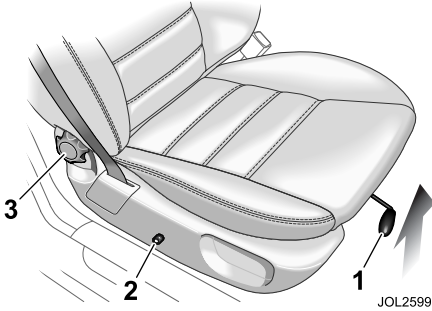

1. Seat fore/aft lever. Lift and slide to position.
2. Seat height switch.
3. Seat back angle wheel.

4-way electrical seat adjustment

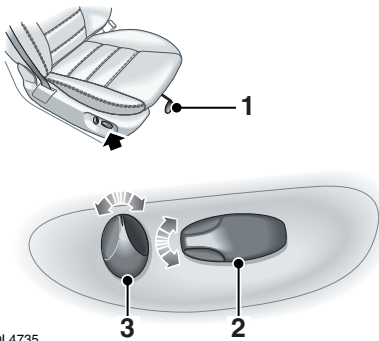

1. Seat fore/aft lever. Lift and slide to position.
2. Seat height switch.
3. Seat back angle switch.

10-way electrical seat adjustment

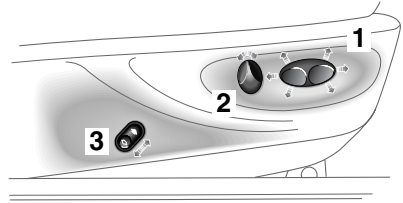

1. Seat position switch. Controls fore/aft position and front and rear cushion height.
2. Seat back angle switch.
3. Lumbar support switch.

Passenger seat

If the passenger seat is fitted with only 2-way electrical adjustment, switch **3** adjusts the seat back angle.

Electrical seat adjustment - memory seats

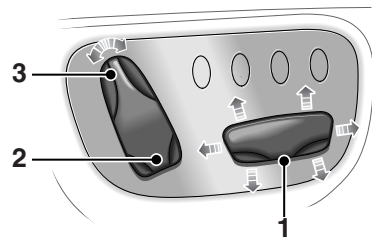

1. Seat position switch. Controls fore/aft position and front and rear cushion height.
2. Seat back angle switch.
3. Lumbar support switch.

Quick Overview

WINDOWS/DOOR MIRRORS

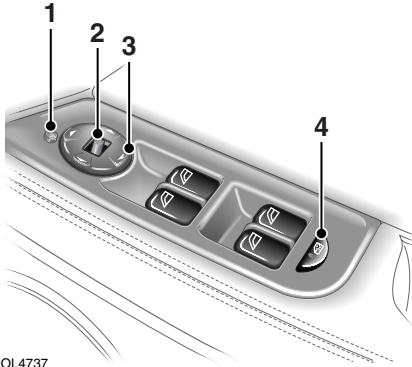

JOL4737

Windows

The windows can be fully opened or closed with a single operation of the switch.

- To open the window, fully press the respective switch. Press the switch again to stop the window from fully opening.
- To close the window, pull the switch fully up. Pull the switch again to stop the window from fully closing.

To partially open a window, lightly press the appropriate switch and release when the window reaches the required position.

Press button **1** to inhibit the operation of the rear window switches.

Door mirrors

Select the appropriate mirror using selector switch **3**. Use the 4-way switch **2** to adjust the position of the mirror glass.

Power fold mirrors

The mirrors can be folded towards the door for better clearance/protection. With the ignition switch in position **I** or **II**, press button **4** to fold the mirrors. A second press returns the mirrors to their normal position.

Global closing

If a window has been left open when leaving the vehicle, it can be closed by pressing and holding the lock button on the remote handset (this will also close the sunroof).

Quick Overview

DRIVING POSITION MEMORY

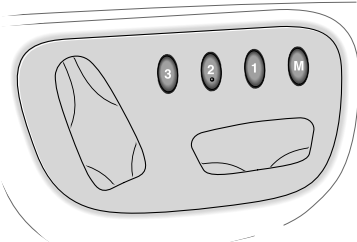

JOL4738

Once you have adjusted the driver's seat and exterior mirrors for your ideal driving position, the vehicle can memorise these settings for future use.

1. With the starter switch in position **I** or **II** press the **M** button on the driver's seat switchpack. A chime will sound to indicate that the seat is in memory mode.
2. Within five seconds, press button **1**, **2** or **3** to memorise the current settings.

A double chime will sound to confirm that the settings are memorised. Any existing settings will be overwritten.

To recall a memorised driving position press button **1**, **2** or **3**. This feature will only operate if the automatic transmission in **P** (Park) or **N** (Neutral), or the starter switch is off in vehicles with manual transmission.

STEERING COLUMN LOCK ADJUSTMENT

Steering column

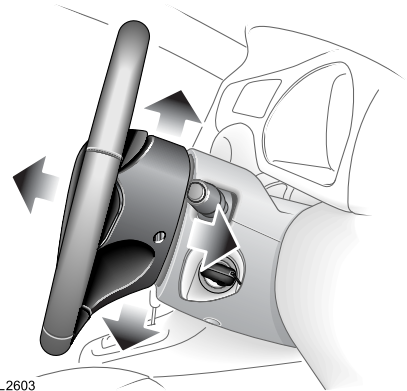
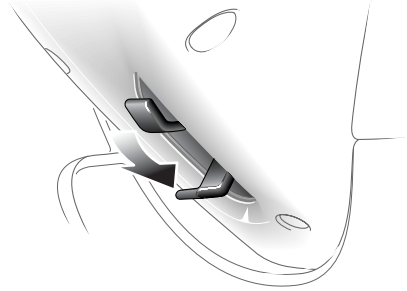

JOL2603

Push steering column adjustment lever downwards.

Move the steering wheel to the required position then fully raise the lever to lock the steering column in position.

Quick Overview

SEAT BELTS/CHILD RESTRAINTS



WARNING:

The use of front and rear seat belts is mandatory in most countries. Using seat belts saves lives. They should be worn by all occupants whenever the vehicle is in use.



A warning indicator on the instrument pack will illuminate to alert you that the driver's and/or front passenger's seat belt is unbuckled. Dependent upon specification this may be accompanied by an intermittent chime.

Child Seats

It is important to remember that your child's weight, rather than age, determines the type of seat that is required.

Refer to **Child Safety** to determine the correct seat for your child, see page 64.

Rear centre seat belt interlock - Estate only

The centre rear seat belt is anchored to the back of the seat. If the seat backrest is not correctly latched the seat belt reel will not extend.

Automatic Locking Reels

Passenger seat belts have ALR fitted for use with child seats.

- To engage: extend the belt to maximum length to enable locking mechanism.
- To disengage: unbuckle the belt and allow belt to fully retract.

With ALR enabled, as the seat belt retracts it will automatically lock, preventing re-extension.

Ensure passengers do not fully extend the restraints and inadvertently engage this feature during normal use.

Quick Overview

ELECTROCHROMATIC REAR VIEW MIRROR

With the ignition switch on, the rear view mirror will automatically darken to counteract glare from the headlamps of a following vehicle.

When enable, this feature is automatically switched off when reverse gear is selected.

Operating note

- This feature is enabled when the button on the underside of the mirror is depressed.

OVERHEAD CONSOLE

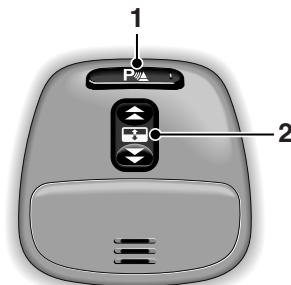

JOL4739

Sunroof

The sunroof is fitted with a facility that allows it to be fully opened or closed with a single operation of switch 2.

Closing remotely

- If the sunroof has been left open when leaving the vehicle, it can be closed by pressing and holding the lock button on the remote handset.

Parking assist

Press button 1 to turn on/off the front and rear parking sensors. An indicator will illuminate in the switch when the system is turned on.

Care points

- Sensors may activate on detection of water, snow or ice on their surface. This is entirely normal and regular cleaning will aid performance.
- Parking assist may sound if it detects a signal operating at the same frequency to that of the sensors (e.g. Motorcycles, Airbrakes).

Quick Overview

CLIMATE CONTROL



JOL4740



JOL4702

These are the primary functions of the climate control system.



For those vehicles fitted with the touch-screen navigation system, the advanced climate control functions can be accessed by pressing the **CLIMATE** button.

AUTO (automatic) mode

 Press to select automatic operation of the climate control system. The system will automatically adjust the heat output, blower speed, air intake and airflow distribution to maintain the selected temperature(s) and reduce misting without constant adjustments by the driver or passengers.

Screen heaters and timed air recirculation may be selected whilst in **AUTO** mode. Selecting any other function will cancel **AUTO** operation.

Recommended mode

- Select **AUTO** as the normal operating mode. This will help prevent window misting and odours from the climate control system.

Air conditioning (A/C)



Air conditioning is an integral part of the climate control system, providing cooled and dehumidified air for occupant comfort; the dry airflow is also effective in preventing misting of the windows.

Press button to switch the air conditioning system on or off.

External water deposits

- The air conditioning system removes moisture from the air and deposits the excess water beneath the vehicle. Puddles may form, but this is normal and no cause for concern.

Air recirculation



Air recirculation is used to stop outside odours from entering the vehicle or to improve performance of the air conditioning system in regions of high ambient temperatures.

Press the button to switch timed air recirculation system on or off.

Quick Overview

Temperature selection



Press the red buttons to increase temperature and the blue buttons to decrease temperature.

To quickly jump from **HI** or **LO** to a mid range temperature setting, press and hold the **AUTO** button for a few seconds.

Defrost/demist mode



Press the **DEF** button to remove frost or heavy misting from the windscreen. The rear screen and windscreen heaters will be activated.

To deselect defrost mode, press **AUTO**. The rear screen and windscreen heaters will remain on.

Heated screens and door mirrors



The front and rear screen heaters can be switched on or off in any

mode, even when the climate control system is off, but will only operate when the engine is running.

Operating the **DEF** button will automatically activate the front and rear screen heaters.

The door mirror heaters are controlled by the rear screen heater button.

Quick Overview

FACIA AND CONTROLS

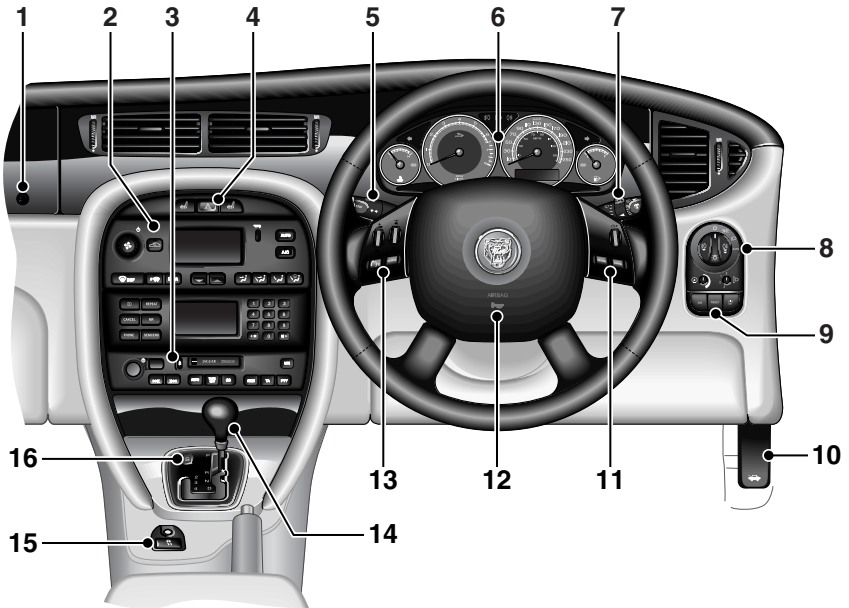

JOL4743

1. Passenger airbag deactivation indicator (59)
2. Heating and ventilation system (152)
3. Audio system
4. Hazard warning switch (110)
5. Direction indicators/trip computer switch (110)
6. Instrument pack/warning indicators (90)
7. Wiper/washer switch (119)
8. Lamps master switch (107)
9. Trip computer reset switch (103)
10. Bonnet release lever (184)
11. Cruise control switches (105)
12. Horn (116)
13. Audio switches
14. Gear selector lever (127)
15. Dynamic Stability Control (DSC) switch (134)
16. Sport mode switch (129)

Page numbers (shown in brackets) refer to pages in this Handbook that have further relevant information.

Quick Overview

Passenger airbag deactivation indicator



The front passenger seat is fitted with an occupancy sensor that determines the state of seat occupancy and sets the airbag status to suit:

- Seat unoccupied - airbag deactivated and indicator off.
- Seat occupied - airbag activated and indicator off.
- Seat occupied by a child, child seat or low weight object - airbag deactivated and indicator on.
- Passenger too close to airbags - airbag deactivated and indicator on.

For further information refer to **Occupant Protection**, see page 59.

Diesel Particle Filter (DPF) indicators

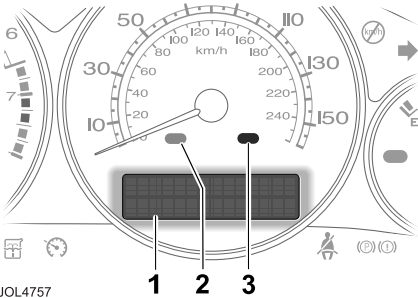

JOL4757

If the AMBER warning indicator **2** is illuminated, accompanied by the message **DPF FULL SEE HANDBOOK** in the message centre **1**, regeneration of the DPF is required. See page 144.

If the RED warning indicator **3** is illuminated, accompanied by the same warning message, seek qualified assistance as soon as possible. See page 144.

EXTERIOR LAMPS/TRIP COMPUTER

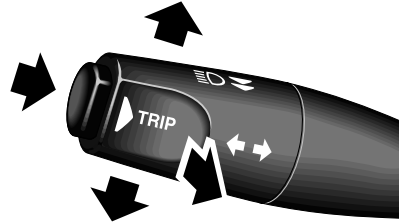

JOL4741

Move the stalk up or down to activate the direction indicators.

Pull the stalk to the first position and release to flash the headlamps. Pull the stalk to the second position and release to switch on the main beam. To switch off the main beam, again pull the stalk to the second position and release.

Press the button on end of stalk to cycle through trip computer displays.

Quick Overview

Lamps master switch

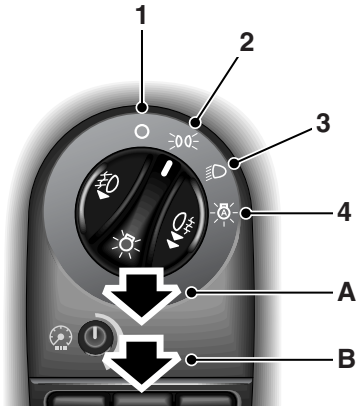

JOL4744

1. Off
 2. Sidelamps
 3. Dipped headlamps
 4. Autolamps
- A. Front fog lamps
B. Rear fog lamps

Pull switch to operate.

Autolamps

If Autolamps is selected, a sensor monitors the exterior light levels and will automatically switch the sidelamps and dipped headlamps ON and OFF. With Autolamps selected, if the windscreen wipers are operated continuously for more than 20 seconds, then the exterior lamps will be switched **ON** automatically.

Fog lamps cannot be activated when Autolamps is selected.

WIPERS AND WASHERS

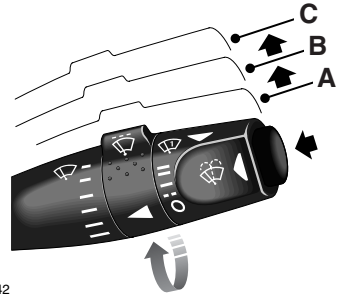

JOL4742

- A. Intermittent wipe.
B. Low speed operation
C. High speed operation.

Press button for windscreen wash/wipe.

Pull the stalk to operate the rear wash/wipe (if fitted).

Rotate the collar to adjust the speed of the intermittent wipe or to select **AUTO** for automatic operation of wipers.

Enabling automatic operation

- The wiper stalk must be in position **A** and **AUTO** selected on the collar to enable automatic operation of the wipers.

Quick Overview

WARNING INDICATORS



Low oil pressure



Diesel glow plugs active/malfunction



Battery charge indicator



Low washer fluid level



Seat belt reminder



Sidelamps on



Hand brake on/brake fluid low



Headlamp main beam on



Transmission malfunction detected



Front fog lamps on



Anti-lock braking system



Rear fog lamps on



Engine malfunction detected



Direction indicators



Dynamic Stability Control (DSC) off



Cruise control active



Door/luggage compartment open



Low outside temperature



Airbag system fault detected

Quick Overview

AUTOMATIC TRANSMISSION

Gearshift interlock

The ignition switch must be in position **II** and the foot brake applied before the gear selector can be moved from **P** (Park) to **R** (Reverse).

The lever can be moved into **P** with the starter switch off.

Gear selector

The J-gate gear selector lever is designed to accommodate two different driving techniques as follows:

- Automatic selection: the right-hand side of the selector gate.
- Manual selection: the left-hand side of the selector gate to individually select 4th, 3rd or 2nd gear.

After selecting **R** (Reverse) or **D** (Drive) from **N** (Neutral) or **P** (Park), wait briefly for the transmission to engage before accelerating.

Kickdown mode

Kickdown provides maximum engine performance in circumstances where rapid acceleration is required, such as when overtaking. Kickdown is operated when the accelerator pedal is pressed fully down, beyond the normal operating spring pressure. This causes the transmission to change down to the lowest gear possible to achieve maximum acceleration.

Kickdown mode is in effect for as long as the pedal is fully depressed.

After selecting **R** (Reverse) or **D** (Drive) from **N** (Neutral) or **P** (Park), wait briefly for the transmission to engage before accelerating.

Sports mode

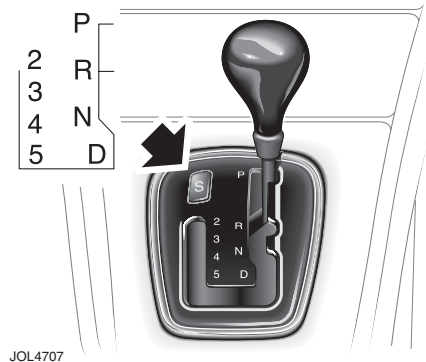

JOL4707

Press the switch (arrowed) to select sports mode. A red indicator in the switch will illuminate to indicate that sports mode is active. When sports mode is selected, the gear change points are modified to make full use of the engine's power.

With the gear selector in **D** (Drive) and Sports mode active, the transmission will use 5th gear less at higher cruising speeds.

Fuel consumption will be adversely affected

Quick Overview

CRUISE (SPEED) CONTROL

The cruise control system will maintain a set road speed until either cruise control is cancelled or the brake or clutch pedal is used.

The system is controlled via switches on the steering wheel:

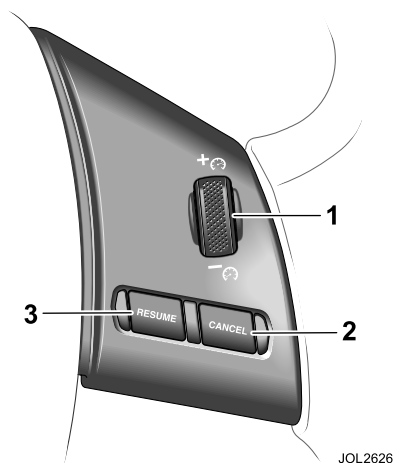

- 1. SPEED ADJUSTMENT WHEEL** - to engage cruise control initially. Also use to increase/decrease the set speed.
- 2. CANCEL** - cancels cruise control but retains the set speed in memory.
- 3. RESUME** - to resume a set speed retained in memory.

Operating note

- Cruise control will automatically disengage when the vehicle speed falls below 28 km/h (18 mph).

DYNAMIC STABILITY CONTROL (DSC)

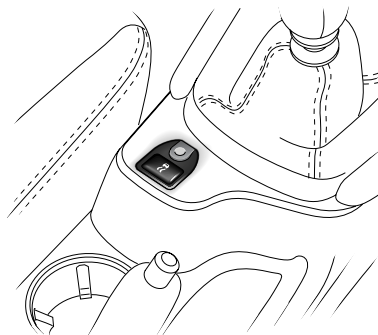

DSC uses traction control and anti-lock braking systems to maximise the vehicle's handling performance and help prevent wheelspin.

DSC is automatically activated when the ignition switch is turned to position II, but can be turned off by pressing the button on the centre console. An amber indicator in the instrument pack will permanently illuminate whenever DSC is switched off.

In the event of a system fault, the message **STABILITY CONTROL FAULT** will also be displayed in the message centre.

Quick Overview

AUDIO SYSTEM KEY FEATURES

General operation

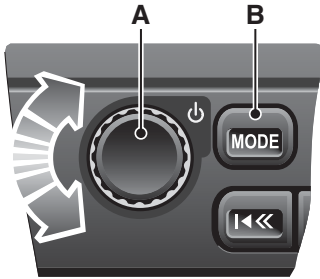

JOL4711

Press the control knob **A** to switch on/off and rotate to adjust the volume.

To adjust the sound settings, press the **MODE** button **B** repeatedly, until the required setting is displayed. Turn the control knob **A** to adjust the level or rating.

After approximately five seconds, the system will return to normal control mode.

Steering wheel controls

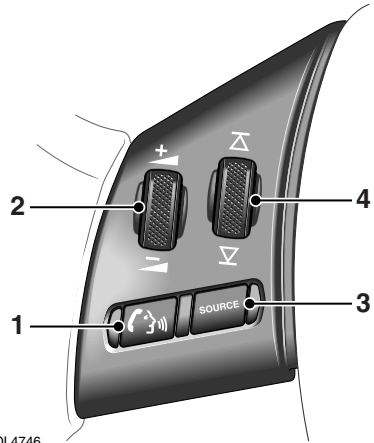

JOL4746

1. Press to mute audio unit (Non-Voice only).
2. Rotate as required to increase or decrease volume.
3. Press and release to cycle through Radio, FM, AM, Cassette, CD, MD and CD multichanger.
4. Rotate and release to cycle through preset radio stations, the next CD/MD track or to use cassette AMS (Automatic Music Search).

Rotate and hold for at least two seconds to cycle to the next strongest station, next CD or change cassette side.

Quick Overview

RADIO OPERATION

 To switch on the radio function, press the **AM/FM** button. Pressing this button repeatedly scrolls through FM, MW and LW wavebands.

 To search for a radio station, press the '**Seek**' arrow buttons.

Setting the radio presets

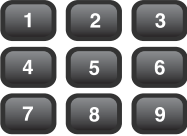
 Once a radio station has been tuned, press and hold the desired preset button (or touch a station position on touch screen) until a 'beep' is heard. The preset is now stored

A total of nine presets can be stored for each waveband.

 The radio presets can be automatically set by using the 'Auto Memory' function. Press and hold the **A MEM** button for two seconds. The radio will be briefly muted while it searches the waveband for the nine strongest stations.

Activating TA (Traffic announcements)

 To activate this function, press and release the **TA** button. With **TA** activated, traffic announcements will interrupt radio, cassette or CD/MD play. To de-activate this feature, press and release the **TA** button again.

Press and hold the **TA** button for two seconds to display the radio station name instead of the frequency.

CD OPERATION

Single CD player

 If the radio or CD multichanger is being used, pressing the **CD** button will resume playing any CD installed in the player mechanism.

When a CD is loaded into the aperture, it will begin to load and play automatically.

Pressing the **CD** button whilst in CD play mode will pause the current track. A subsequent press of the **CD** button will resume play mode.

Six discs can be loaded into the multichanger unit, and a further single disc in the audio console (when fitted).

 To skip tracks, continually press the '**Seek**' arrow buttons to move back or forward accordingly. Pressing and holding these buttons will search through the selected track.

 When a disc is inserted, the CD icon is displayed. Press the Disc Eject button to eject the CD. The display will show **DISC EJECT** and the CD icon will be turned off.

Quick Overview

CD Multichanger

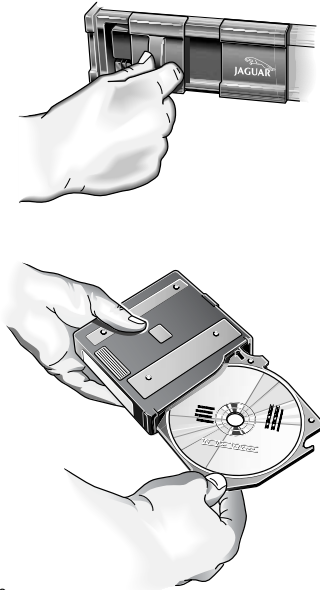

JOL4713

Care point

- Remember to close the multichanger door this will prevent dirt getting into the unit and help reduce skipping.

The CD multichanger is located in the luggage compartment. To load a CD into the multichanger:

- Slide open the multichanger door, press the **Eject** button and remove the magazine. Close the door.
- Pull a tray out from the magazine and insert a CD (label side up). Slide tray into magazine until a 'click' is heard.
- Slide open the multichanger door and ensuring correct orientation, replace the magazine. Ensure the magazine 'clicks' into position.

CD selection

- Press the **CDC** button (CD button on MiniDisc and cassette player systems) to select the CD multichanger mode.
- Press preset buttons **1 - 6** to select the appropriate CD loaded in the multichanger.
If a touch-screen is fitted to the vehicle, disc selection can be made by touching the relevant numbered disc icon.
- When playing a CD, press the **CDC** button to pause play. Press again to continue play.

Playing random tracks

- To play random tracks from the disc, press and release the **MIX** button. To cancel, press the **MIX** button again.

To play random tracks from all discs loaded in the multichanger, press the **MIX** button for two seconds. To cancel, press and hold the **MIX** button.

Quick Overview

NAVIGATION

Caution: The screen allows touch control of the navigation system. The screen only requires a light touch to operate the function. Excess pressure on the screen could result in damage. On initial activation, ensure that both the correct country and area have been selected.

Setting a destination

To set a destination and start using the the navigation system, use the following procedure.

1. Press the **NAV** button (arrowed in illustration) and, when prompted, touch **Agree** on the touch-screen to access the initial map screen.
2. Touch **Nav menu** to access the navigation menu and then touch **Destination Entry**.
3. Touch either **Address** or **Postcode**.
4. Enter the address or postcode using the on-screen keypad, ensuring a space is entered in the postcode. The space character can be found after the Z character on the bottom line of the keypad. Touch **OK** to enter.
5. Touch **Dest** to calculate the route.
6. Once calculated, the screen displays the route. To scroll through alternative routes, touch **Next** on the screen.
Note: Route Preferences should be selected prior to setting a destination. Access is via the Nav menu and then Route Options.
7. Touch **Start** to commence navigation. Drive away following the voice guidance.



Note: Touch the **Audible repeat** icon to hear the last voice instruction again. Audible guidance can be selected or deselected via the **Nav menu**.

8. When your destination is reached, voice and visual confirmation is given.



JOL4714

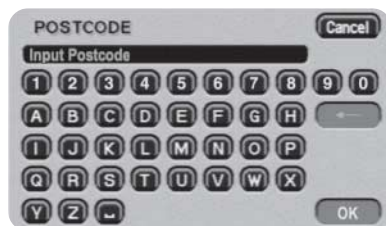

JOL4715v



JOL4716

cancelling guidance

Touch **Nav Menu**, select **Route options**, **Cancel guidance** and touch **Confirm**.

Quick Overview

TELEPHONE - BLUETOOTH SYSTEM

Mobile phones with Bluetooth capability can communicate with the vehicle's inbuilt telephone system.

The following procedure demonstrates how to connect the most popular brands of mobile phone.

Pairing a handset to the vehicle

1. Turn the ignition switch to position II.

2. Press the telephone button on the audio panel. The touch-screen will display the message **No BT phone**. On touch-screen systems the message **SIG** will be displayed.
3. Either using the on-screen or the audio panel keyboard, press **##3##**.
4. Touch the on-screen call icon or press the call button on the audio panel.
5. Prepare the handset for pairing to the system.

See the telephone manufacturer's instructions for further details, or follow the table below for generic commands.

	Nokia	Motorola	Ericsson
1.	Select menu	Select menu	Select menu
2.	Select settings	Select settings	Select connectivity
3.	Select Bluetooth OR Select Connectivity then Bluetooth	Select Connection	Select Bluetooth
4.	Select On	Select Bluetooth link	Select My Devices
5.	Select Search for Audio devices	Select Hands-free	With New Device highlighted, select Add. Press OK to confirm
6.	After search select Jaguar	Select Look for devices	After search select Jaguar
7.	Enter pass code 1313. Press OK to confirm	After search select Jaguar	Select Connect
8.	No connection? Select Bluetooth (Menu) then Paired devices Jaguar	Permission to bond? Select Yes and enter pass code 1313	Enter pass code 1313 after prompt

When the handset has been successfully paired to the system, the touch-screen message changes to **REGISTERED** or **PHONE CONNECTED**. On systems without a touch-screen the audio system message changes to **SIG***.

Note: For best results when pairing your handset to the system, ensure the handset is fully charged.

Quick Overview

Mobile phone compatibility

There are a number of mobile phones that have been tested to function correctly with the Jaguar system, however not all mobile phones are compatible. For the latest list of compatible phones and software versions, please refer to www.ownerinfo.jaguar.com. Alternatively consult your Jaguar Dealer/Authorised Repairer.

Downloading phone book entries

1. Turn the starter switch to position **II**, and ensure the handset is paired to the vehicle's system.
2. Press the telephone button on the audio panel.
3. Either using the on-screen keypad or the audio panel keyboard, press **##2##**.
4. Touch the on-screen call icon or press the call button on the audio panel.
5. Switch off the starter switch for six minutes to allow the system to complete the download process.

Making a call



JOL4746

1. Press and hold the **Source** switch on the steering wheel control, or press the call button on the audio panel. **Phone** will be displayed.
2. Key in the phone number required, using the on-screen or audio panel keyboard.
3. Press the call button on the steering wheel control, or on the audio panel. **Calling** will be displayed.
4. To end the call, press the call button on the steering wheel control, or on the audio panel.

Receiving a call

To answer or end a call, press the call button on the steering wheel control or on the audio panel.

Filling Station Information

FUEL TYPE

Petrol models - Unleaded 95 RON.

Diesel models - Diesel fuel to EN 590 or equivalent.

Caution: DIESEL ENGINES - If you inadvertently fill your vehicle with petrol instead of diesel, do not attempt to start the engine. Contact your Jaguar Dealer/Authorised Repairer immediately.

Attempting to start the engine with petrol in the fuel tank will cause extensive damage to the engine and fuel system, which will not be covered by your Jaguar warranty.

Jaguar can accept no responsibility for any damage caused by running your vehicle with petrol in the fuel tank.

Diesel engines only: Drivers should expect above normal fuel consumption when the engine is new and bedding in. After a period of time, the fuel consumption will gradually improve to expected levels.

Caution: Do not use RME (bio-diesel) except in the case of proprietary diesel fuels which contain a mix of up to 5%.

FUEL FILLING

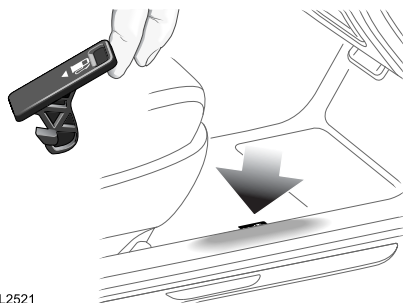

JOL2521

Pull the fuel filler flap release. This is located on the floor, outboard of the driver's seat, see page 140.

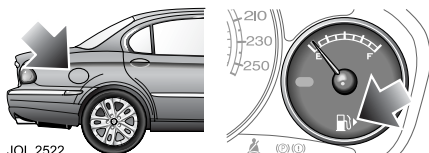

JOL2522

The filler flap is located on the right-hand side of the vehicle.

Note: Vehicles with a diesel engine have a **yellow** filler cap.

For quickness and to completely fill the tank, ensure that the fuel nozzle rests on the bottom of the filler neck.

After refuelling, refit the filler cap in the filler neck and twist the cap clockwise until it clicks three times. Close the flap, which automatically locks shut.

Filling Station Information

BONNET RELEASE

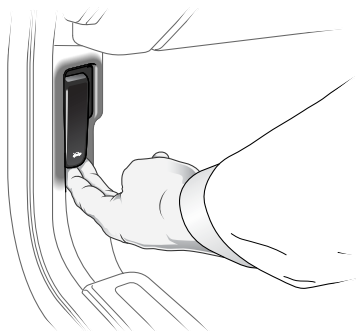

JOL2523

Pull the release lever located below the fascia on the left-hand side of the vehicle, see page 184.

UNDERBONNET TOP-UP

Recommended engine oil

See page 189.

Petrol models -

Castrol 5W-30 to Jaguar specification WSS M2C913 - A or B.

Diesel models -

An oil of 5W-30 to Jaguar specification WSS M2C913 - B must be used in all vehicles with a diesel engine.

For **top-up purposes only**, where oil of specification WSS-M2C-913-B cannot be found, ACEA B1 or ACEA B3 specification oils may be used.

Windscreen/headlight washer reservoir.

See page 190.

Cooling system

50% water/50% anti-freeze, see page 191.

Filling Station Information

TYRE PRESSURES

The tyre pressures for all normal operating conditions are shown on a label fixed to the end of the dashboard on the driver's side of the vehicle.

Check pressures when the tyres are cold (see page 198). Deflating air from a warm tyre to the recommended pressure will result in under inflation which may be dangerous.

For your convenience you may wish to record the tyre pressures in the boxes provided below. If you are unsure of the correct pressures, please contact your Jaguar Dealer/Authorised Repairer.

FRONT

Normal Driving

Laden/High Speed

Spare Wheel

REAR

Normal Driving

Laden/High Speed

Spare Wheel



WARNING:

When using tyres other than those recommended by Jaguar, do not exceed the speed capacity recommended by the manufacturer.